

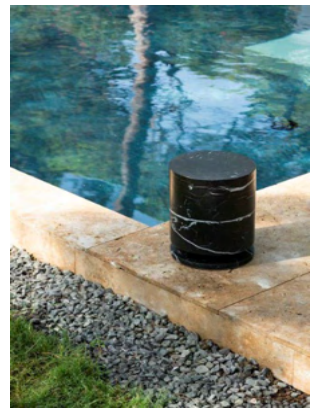































**ARCHI-
TETTURA
SONORA** 
Architettura Sonora
Retail Pricelist

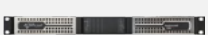

SOUND MATTERS

2022 v1.1
Effective from January 1st, 2022

TABLE OF CONTENTS

DAEDALUS		page 1
		
ICARUS		from page 3
 <p>ICARUS Stand Alone</p>	 <p>Icarus Sub</p>	 <p>Icarus Wall</p>
 <p>Icarus MultiWall</p>	 <p>Icarus MultiCeiling</p>	 <p>Icarus MultiStand</p>
 <p>Icarus MultiGround</p>		
CYLINDER		from page 16
 <p>MEDIUM CYLINDER</p>	 <p>TALL CYLINDER</p>	 <p>CYLINDER TABLE</p>
SPHERE		from page 21
 <p>SPHERE_360</p>	 <p>SPHERE_470</p>	
SPHERINA		from page 25
 <p>SPHERINA_Air</p>	 <p>SPHERINA_Midair</p>	 <p>SPHERINA_Floor</p>
CUBE		from page 31
 <p>CUBINO</p>	 <p>CUBE_400</p>	 <p>CUBE_400 TEN</p>
 <p>CUBE_2LV SUB</p>		
AERIAL		from page 37
 <p>PERGOLA (Line Array/Point Source)</p>	 <p>Small DROP</p>	 <p>Small HELMET</p>
 <p>DROP</p>		
 <p>SHARK (Sub)</p>		
AMPLIFIERS		page 41
 <p>AS Amplifiers</p>	 <p>POWERSOFT Amplifiers</p>	
PROMO KITS		from page 42
 <p>BASIC Sample Kit</p>	 <p>PREMIUM Sample Kit</p>	 <p>T-SHIRT</p>
 <p>BAG</p>		
 <p>CATALOGUE</p>		
Hanging Tube Systems for Suspended Models		page 44
AS Palette (Stone, Terracotta, Concrete and Shine collections)		From page 45

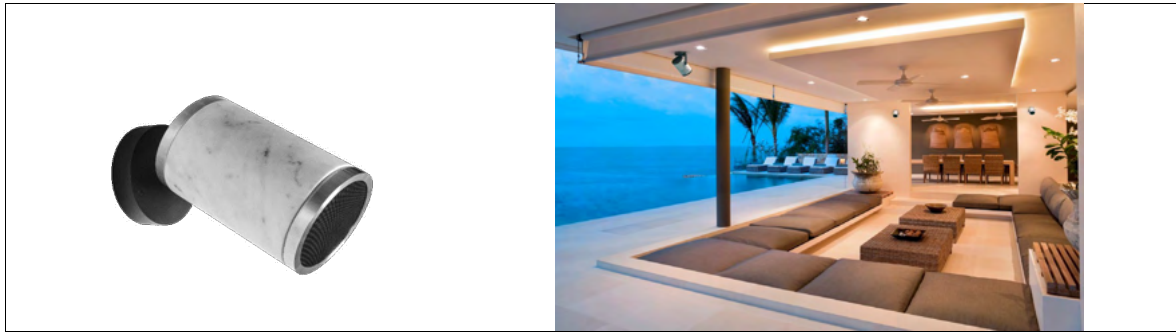

DAEDALUS

in Covered
Areas only



Sellable in pairs only

				REUPx2*
DAE-PPALBLA DAE-PPALSLV		DAEDALUS_Aluminum PAIR-PACK SOLUTION Body in Aluminum All metals in anodized Black aluminium > see table on the next page See variations on Basic Stones palette at the end	 	2.750 €
DAE-PPST03 DAE-PPST04		DAEDALUS_Basic Stones PAIR-PACK SOLUTION Body in Basic Stone All metals in anodized Black aluminium > see table on the next page See variations on Basic Stones palette at the end ST03 ST04 CARW MARQ	 	€ 4.200
DAE-PPPM		DAEDALUS_Premium PAIR-PACK SOLUTION Body in Premium Stone All metals in anodized Black aluminium > see table on the next page See variations on Premium Stones palette at the end	 	POR

*prices refer to no.2 units

MAIN FUNCTIONAL OPTIONS

Please note that price for all the following options has to be added to the main model price

REF CODE			REUPx2*
DAE-PP-HZ10		HIGH IMPEDANCE ON BOARD 70/100V - 10W	€ 70

*prices refer to options for both 2 units

CUSTOMIZATION & ACCESSORIES

Please note that price for all following options and accessories has to be added to the main model price



BODY OPTIONS

REF CODE			REUPx2*
DAE-PPBDRAL		Aluminum BODY painted in ALL RAL colors	€ 150

*prices refer to options for both 2 units

CUSTOMIZATION & ACCESSORIES

Please note that price for all the following options and accessories has to be added to the main model price

REF CODE			REUPx4**
DAE-COV-PPPOL316		Only COVERS (front and rear) in POLISHED 316L Steel > see table on the next page	€ 520
DAE-COV-PPSAT316		Only COVERS (front and rear) in SATIN 316L Steel > see table on the next page	€ 520
DAE-COV-PPBRS		Only COVERS (front and rear) in oxidized BRASS > see table on the next page	€ 520

**prices refer to the (front and rear) COVERS for no.2 complete Daedalus, tot. 4 pieces

METAL FINISHES TABLE



in Covered Areas only

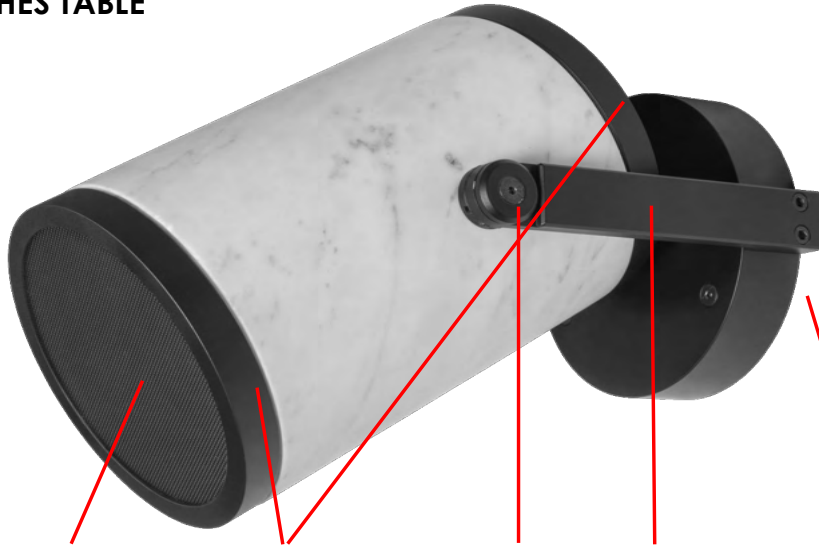

VERSION	GRID	COVERS (front & rear)	JOINT	ARM	PLATE
BLACK ANODIZED ALUMINUM	BLACK	MATT BLACK ALUM.	MATT BLACK	MATT BLACK	MATT BLACK
POLISHED 316L STEEL	BLACK	POLISHED 316L	MATT BLACK	MATT BLACK	MATT BLACK
SATIN 316L STEEL	BLACK	SATIN 316L	MATT BLACK	MATT BLACK	MATT BLACK
BRASS	BLACK	OXIDIZED BRASS	MATT BLACK	MATT BLACK	MATT BLACK

Standard version highlighted in red

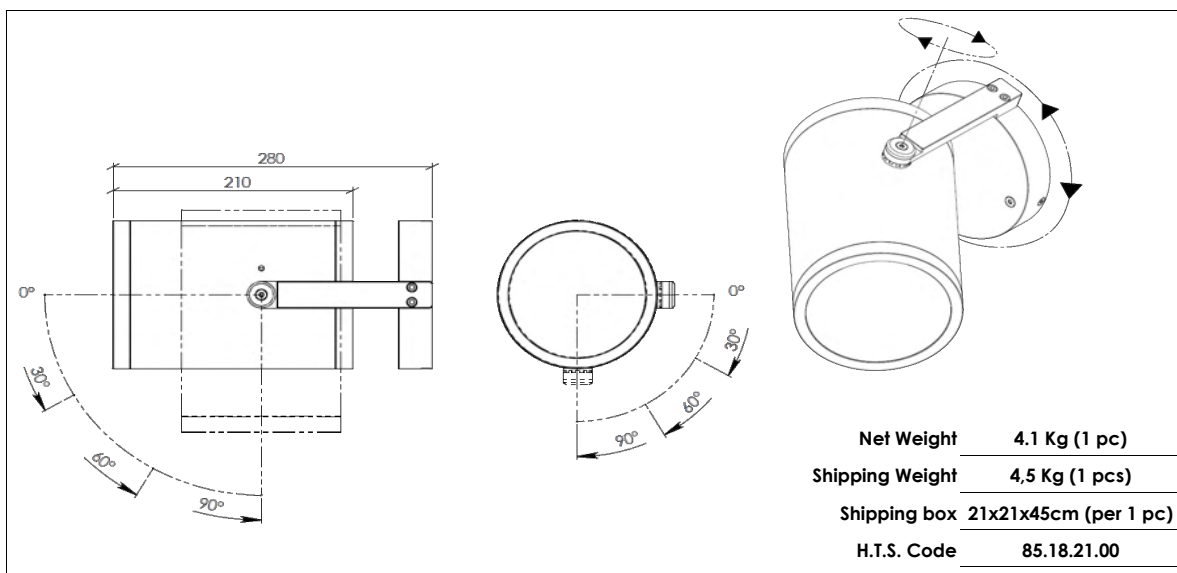



ICARUS_Stand Alone

in Covered
Areas only



REF CODE					REUP
ICA-CN			ICARUS_Concrete Bodies in Concrete Metal parts in polished Steel 304 > <i>see table on the next page</i> See variations on concrete palette at the end	 	€ 4.300
ICA-CNP					
ICA-CNW					
ICA-CNR					
ICA-CNB					
			CN GREY CNP BLACK CNW WHITE CNR RED CNB OceanBlue		
ICA-ST01			ICARUS_Basic Stones Bodies in Basic Stones Metal parts in polished Steel 304 > <i>see table on the next page</i> See variations on Concrete palette at the end	 	€ 8.500
ICA-ST02					
ICA-ST03					
ICA-ST04					
			ST01 TRVC ST02 TRVV ST03 CARW ST04 MARQ		
ICA-PM			ICARUS_Premium Bodies in Premium Stones Metal parts in polished Steel 304 > <i>see table on the next page</i> See variations on Premium Stones palette at the end	 	POR

MAIN FUNCTIONAL OPTIONS

Please note that price for all the following options has to be added to the main model price

REF CODE			REUP
ICA-HZ60		HIGH IMPEDANCE ON BOARD 70/100V - 60W	€ 250

CUSTOMIZATION & ACCESSORIES

Please note that price for all the following options and accessories has to be added to the main model price

REF CODE			REUP
ICA-MTL-BLK		Metal parts in MATT BLACK painted 304 Steel > <i>see table on the next page</i>	€ 630
ICA-MTL-SAT		Metal parts in SATIN-finished 304 Steel > <i>see table on the next page</i>	€ 800
ICA-MTL-BRS		Metal parts in oxidized Brass > <i>see table on the next page</i>	€ 850
PLAST-ICA		Plaster treatment for travertines	€ 350
POL-ICA		Polishing treatment for all marbles	€ 280
COVER-ICA-B		PVC Basic Envelope	€ 170

METAL FINISHES TABLE



in Covered Areas only

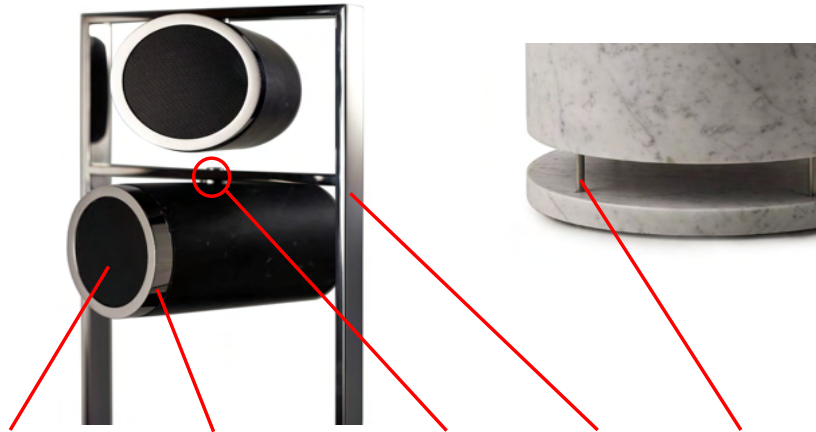















VERSION	GRID	COVER	JOINT	FRAME	LEGS
POLISHED 304 STEEL	BLACK	POLISHED 304	POLISHED 304	POL 304	POLISHED 304
SATIN 304 STEEL	BLACK	SATIN 304	SATIN 304	SAT 304	SATIN 304
BLACK PAINTED 304 STEEL	BLACK	MATT BLACK 304	POLISHED 304	BLACK 304	BLACK 304
BRASS	BLACK	OXIDIZED BRASS	OXIDIZED BRASS	BRASS	OX. BRASS

Standard version highlighted in red

Net Weight	31 Kg Concrete 34 Kg Marble
Shipping Weight	38 Kg 42 Kg
Shipping Box	180x40x40 cm
H.T.S. CODE	85.18.22.00



ICARUS_SUB

REF CODE			REUP
ICASUB-CN ICASUB-CNP ICASUB-CNW ICASUB-CNR ICASUB-CNB	 <p>ICARUS SUB_Concrete Body in Concrete Aluminium matt black painted legs > <i>see table on the next page</i> See variations on Concrete palette at the end</p> <p>  CN GREY  CNP BLACK  CNW WHITE  CNR RED  CNB OceanBlue </p>		€ 1.450
ICASUB-ST01 ICASUB-ST02 ICASUB-ST03 ICASUB-ST04	 <p>ICARUS SUB_Basic Stones Body in Basic Stone Aluminium matt black painted legs > <i>see table on the next page</i> See variations on concrete palette at the end</p> <p>  ST01 TRVC  ST02 TRVV  ST03 CARV  ST04 MARQ </p>		€ 3.500
ICASUB-PM	 <p>ICARUS SUB_Premium Body in Premium Stone Aluminium matt black painted legs > <i>see table on the next page</i> See variations on concrete palette at the end</p>		POR

MAIN FUNCTIONAL OPTIONS

Please note that price for all the following options has to be added to the main model price

ICASUB-HZ30		HIGH IMPEDANCE ON BOARD 70/100V - 30W	€ 90
ICASUB-HZ60		HIGH IMPEDANCE ON BOARD 70/100V - 60W	€ 120

CUSTOMIZATION & ACCESSORIES



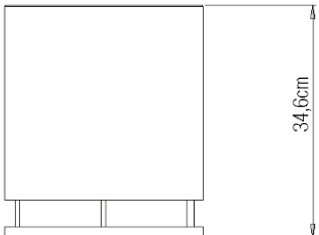
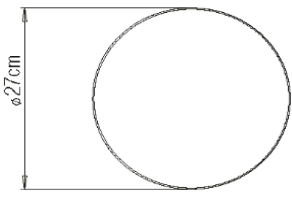

Please note that price for all the following options and accessories has to be added to the main model price

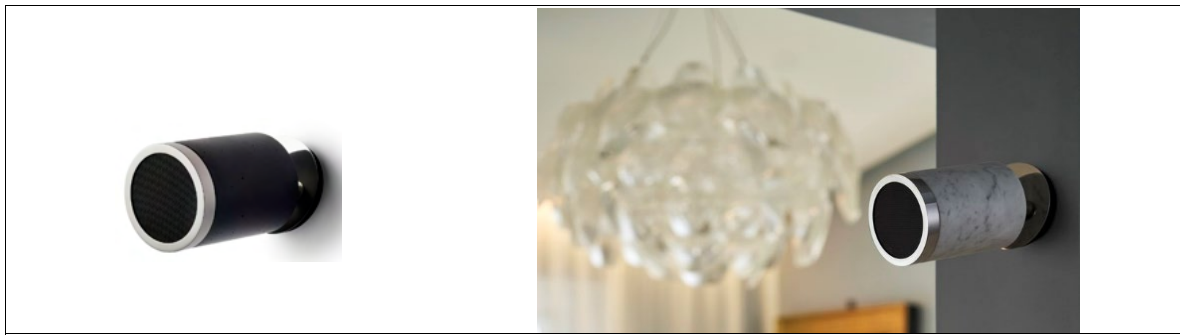
REF CODE		REUP
ICASUB-LGS-SAT	SATIN-finished Steel 304 Legs > <i>see table on the next page</i>	€ 160
ICASUB-LGS-POL	POLISHED Steel 304 Legs > <i>see table on the next page</i>	€ 190
ICASUB-LGS-POL316	POLISHED Steel 316L Legs > <i>see table on the next page</i>	€ 270
ICASUB-LGS-BRS	Oxidized BRASS Legs > <i>see table on the next page</i>	€ 220
PLAST-ICASUB	Plaster treatment for travertines	€ 200
POL-ICASUB	Polishing treatment for all marbles	€ 140
COVER-ICASUB-B	PVC Basic Envelope	€ 90













		<table border="1"> <tr> <td>Net Weight</td> <td>22 Kg Concrete 24 Kg Marble</td> </tr> <tr> <td>Shipping Weight</td> <td>24 Kg Concrete; 27 kg Marble</td> </tr> <tr> <td>Shipping Box</td> <td>40x40x45 cm</td> </tr> <tr> <td>H.T.S. CODE</td> <td>85.18.21.00</td> </tr> </table>	Net Weight	22 Kg Concrete 24 Kg Marble	Shipping Weight	24 Kg Concrete; 27 kg Marble	Shipping Box	40x40x45 cm	H.T.S. CODE	85.18.21.00
Net Weight	22 Kg Concrete 24 Kg Marble									
Shipping Weight	24 Kg Concrete; 27 kg Marble									
Shipping Box	40x40x45 cm									
H.T.S. CODE	85.18.21.00									



ICARUS_WALL

FIXED Joint Version				
REF CODE			REUPx2*	
ICAWALL-FIX-PPCN		ICARUS WALL_Fixed Joint_Concrete PAIR-PACK Body in Concrete Covers in polished Steel 304 > see table on the next page See variations on Concrete palette at the end	 	€ 1.250
ICAWALL-FIX-PPCNP				
ICAWALL-FIX-PPCNW				
ICAWALL-FIX-PPCNR				
ICAWALL-FIX-PPCNB				
	CN GREY CNP BLACK CNW WHITE CNR RED CNB OceanBlue			
ICAWALL-FIX-PPST01		ICARUS WALL_Fixed Joint_Basic Stones PAIR-PACK SOLUTION Body in Basic Stone Covers in polished Steel 304 > see table on the next page See variations on Basic Stones palette at the end	 	€ 2.950
ICAWALL-FIX-PPST02				
ICAWALL-FIX-PPST03				
ICAWALL-FIX-PPST04				
	ST01 TRVC ST02 TRVW ST03 CARW ST04 MARQ			
ICAWALL-FIX-PPPM		ICARUS WALL_Fixed Joint_Premium PAIR-PACK SOLUTION Body in Premium Stone Covers in polished Steel 304 > see table on the next page See variations on Premium Stones palette at the end	 	POR

*prices refer to nr.2 units in a single carton box

SPHERICAL Joint Version				
REF CODE			REUPx2*	
ICAWALL-SPH-PPCN		ICARUS WALL_Spherical Joint_Concrete PAIR-PACK SOLUTION Body in Concrete Covers in polished Steel 304 > see table on the next page See variations on Concrete palette at the end	 	€ 1.400
ICAWALL-SPH-PPCNP				
ICAWALL-SPH-PPCNW				
ICAWALL-SPH-PPCNR				
ICAWALL-SPH-PPCNB				
	CN GREY CNP BLACK CNW WHITE CNR RED CNB OceanBlue			
ICAWALL-SPH-PPST01		ICARUS WALL_Spherical Joint_Basic Stones PAIR-PACK SOLUTION Body in Basic Stone Covers in polished Steel 304 > see table on the next page See variations on Basic Stones palette at the end	 	€ 3.100
ICAWALL-SPH-PPST02				
ICAWALL-SPH-PPST03				
ICAWALL-SPH-PPST04				
	ST01 TRVC ST02 TRVW ST03 CARW ST04 MARQ			
ICAWALL-SPH-PPPM		ICARUS WALL_Fixed Joint_Premium PAIR-PACK SOLUTION Body in Premium Stone Covers in polished Steel 304 > see table on the next page See variations on Premium Stones palette at the end	 	POR

*prices refer to nr.2 units in a single carton box

MAIN FUNCTIONAL OPTIONS





Please note that price for all the following options has to be added to the main model price

REF CODE		REUPx2*
ICAWALL-PPHZ10	 HIGH IMPEDANCE ON BOARD 70/100V - 10W	€ 65

*prices refer to nr.2 units in a single carton box

CUSTOMIZATION & ACCESSORIES

Please note that price for all the following options and accessories has to be added to the main model price

REF CODE		REUPx2*
ICAWALL-MTL-PPBLK	 Metal parts in MATT BLACK painted 304 Steel > see table on the next page	€ 190
ICAWALL-MTL-PPSAT	 Metal parts in SATIN-finished 304 Steel > see table on the next page	€ 305
ICAWALL-MTL-PPPOL316	 Metal parts in POLISHED 316L Steel > see table on the next page	€ 990
ICAWALL-MTL-PPBRS	 Metal parts in oxidized BRASS > see table on the next page	€ 770
PLAST-ICAWALL	Plaster treatment for travertines	€ 140
POL-ICAWALL	Polishing treatment for all marbles	€ 100
COVER-ICAWALL-P	PVC Premium Cover	€ 90

*prices refer to treatments and options applied on nr. 2 pieces

METAL FINISHES TABLE

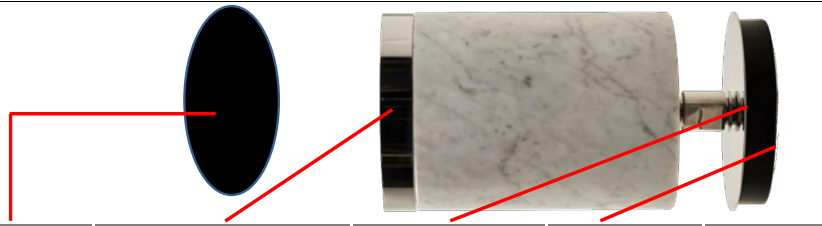

VERSION	GRID	COVER	JOINT*	DISC	PLATE
POLISHED STEEL 304	BLACK	POLISHED 304	POLISHED 304	POL 304	MATT BLACK 304
SATIN 304 STEEL	BLACK	SATIN 304	SATIN 304	SAT 304	MATT BLACK 304
POLISHED 316L STEEL	BLACK	POLISHED 316L	POLISHED 316L	POL 316L	MATT BLACK 304
BLACK PAINTED 304 STEEL	BLACK	MATT BLACK 304	POLISHED 304	BLACK 304	MATT BLACK 304
BRASS	BLACK	OXIDIZED BRASS	OXIDIZED BRASS	BRASS	MATT BLACK 304

Standard version highlighted in red

*In the "Fixed Joint" version, the joint is always in POLISHED steel 304

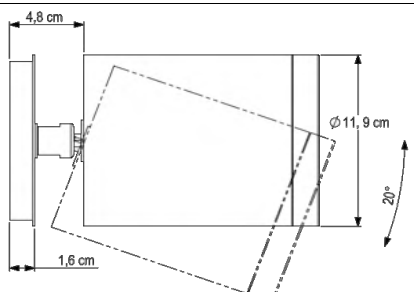

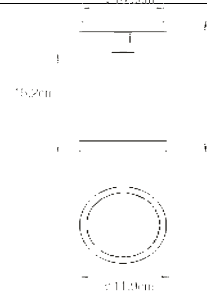

Net Weight 5 Kg (2 pcs)

Shipping Weight 6 Kg (2 pcs)

Shipping box 34x38x20 cm



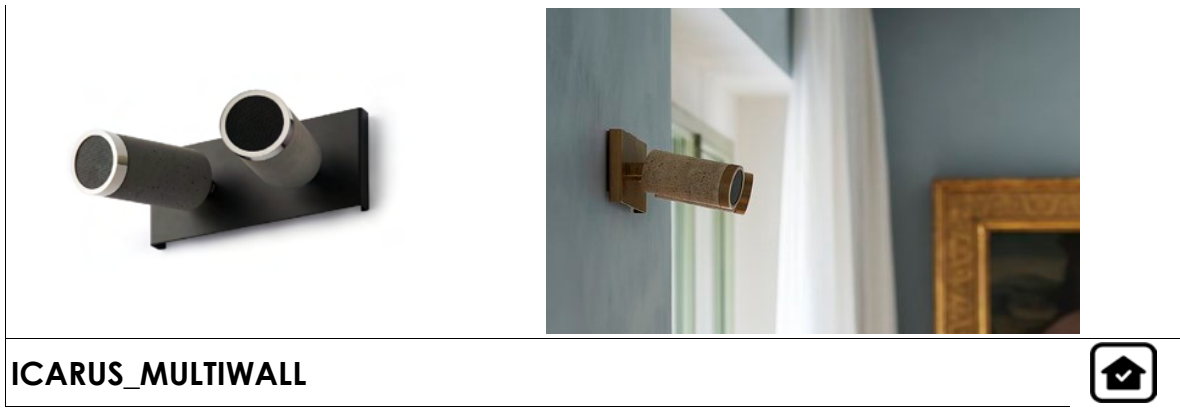









H.T.S. Code 85.18.21.00



ICARUS_MULTIWALL



only indoors

REF CODE			REUP
ICAMLWL-CN ICAMLWL-CNP ICAMLWL-CNW ICAMLWL-CNR ICAMLWL-CNB		ICARUS MULTI-WALL_Concrete Without Crossover - Bodies in Concrete Plate in black painted metal Covers and Spherical Joint in polished Steel 304 > see table on the next page Only for indoor use See variations on Concrete palette at the end CN CNP CNW CNR CNB GREY BLACK WHITE RED OceanBlue	   € 1.150
ICAMLWL-ST01 ICAMLWL-ST02 ICAMLWL-ST03 ICAMLWL-ST04		ICARUS MULTI-WALL_Basic Stones Without Crossover - Bodies in Basic Stones Plate in black painted metal Covers and Spherical Joint in polished Steel 304 > see table on the next page Only for indoor use See variations on Basic Stones palette at the end ST01 ST02 ST03 ST04 TRVC TRVW CARW MARQ	   € 2.000
ICAMLWL-PM		ICARUS MULTI-WALL_Premium Without Crossover - Bodies in Premium Stones Plate in black painted metal Covers and Spherical Joint in polished Steel 304 > see table on the next page Only for indoor use See variations on Premium Stones palette at the end	   POR





MAIN FUNCTIONAL OPTIONS

Please note that price for all the following options has to be added to the main model price

REF CODE			REUP
ICAMLWL-HZ20		HIGH IMPEDANCE ON BOARD 70/100V - 20W	€ 70

CUSTOMIZATION & ACCESSORIES

Please note that price for all the following options and accessories has to be added to the main model price

REF CODE			REUP
ICAMLWL-MTL-BLK		Metal parts in MATT BLACK painted 304 Steel > see table on the next page	€ 200
ICAMLWL-MTL-SAT		Metal parts in SATIN-finished 304 Steel > see table on the next page	€ 410
ICAMLWL-MTL-POL		Metal parts in POLISHED 304 Steel > see table on the next page	€ 270
ICAMLWL-MTL-BRS		Metal parts in oxidized BRASS > see table on the next page	€ 550
PLAST-ICAMLWL		Plaster treatment for travertines	€ 85
POL-ICAMLWL		Polishing treatment for all marbles	€ 70

METAL FINISHES TABLE



Only Indoors

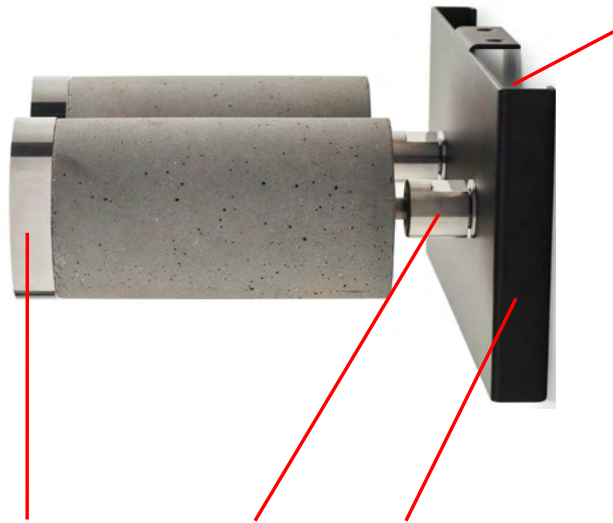
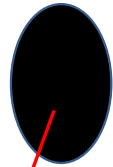





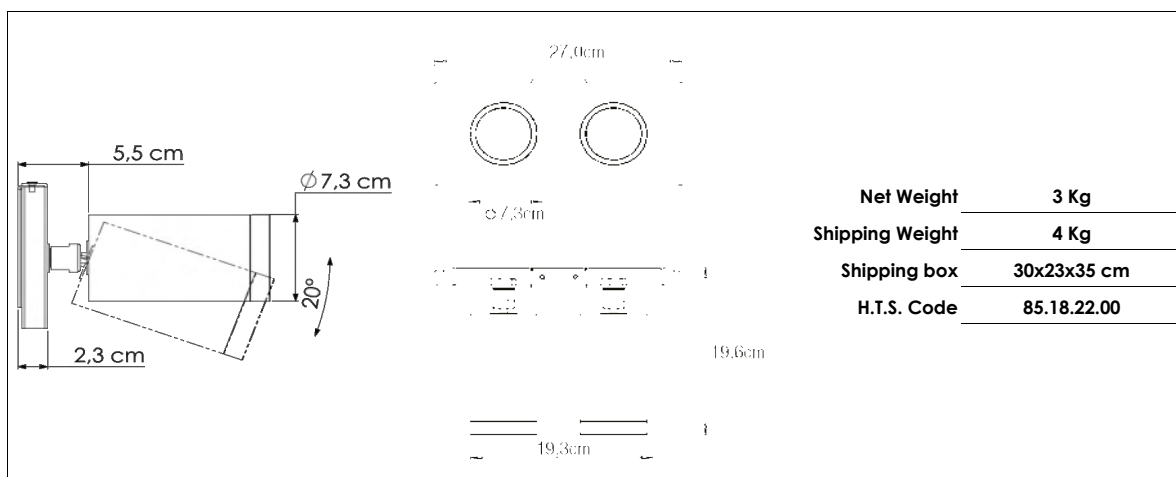

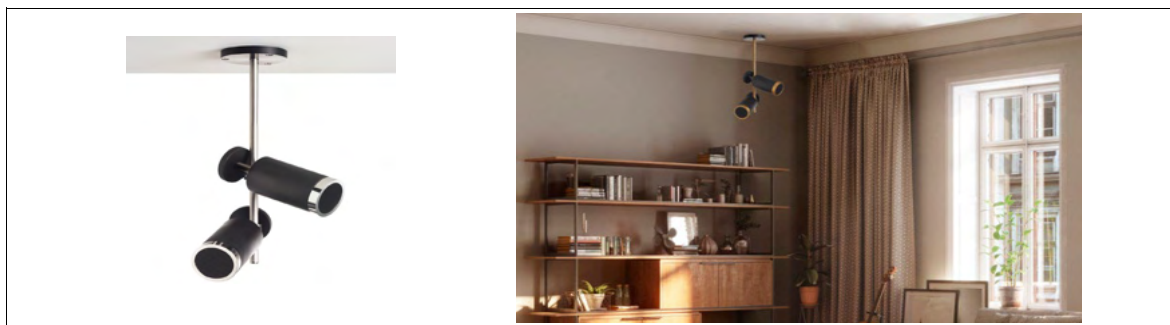

VERSION	GRID	COVER	JOINT	FRONT PLATE	REAR WALL SUPPORT
STANDARD MIX	BLACK	POLISHED 304	POLISHED 304	MATT BLACK	BLACK
POLISHED 304 STEEL	BLACK	POLISHED 304	POLISHED 304	POLISHED 304	BLACK
SATIN 304 STEEL	BLACK	SATIN 304	SATIN 304	SATIN 304	BLACK
BLACK PAINTED 304 STEEL	BLACK	304 BLACK	POLISHED 304	BLACK	BLACK
BRASS	BLACK	OXIDIZED BRASS	OXIDIZED BRASS	OX. BRASS	BLACK

Standard version highlighted in red





ICARUS_MULTICEILING

REF CODE			REUP
ICAMLCE-CN ICAMLCE-CNP ICAMLCE-CNW ICAMLCE-CNR ICAMLCE-CNB	 <p>ICARUS MULTICEILING_Concrete Without Crossover - Bodies in Concrete Metal parts in polished Steel 304 > see table on the next page See variations on Concrete palette at the end</p> <p> CN CNP CNW CNR CNB GREY BLACK WHITE RED OceanBlue </p>	 	€ 1.550
ICAMLCE-ST01 ICAMLCE-ST02 ICAMLCE-ST03 ICAMLCE-ST04	 <p>ICARUS MULTICEILING_Basic Stones Without Crossover - Bodies in Basic Stone Metal parts in polished Steel 304 > see table on the next page See variations on Basic Stones palette at the end</p> <p> ST01 ST02 ST03 ST04 TRVC TRVW CARW MARQ </p>	 	€ 3.550
ICAMLCE-PM	 <p>ICARUS MULTICEILING_Premium Without Crossover - Bodies in Premium Stone Metal parts in polished Steel 304 > see table on the next page See variations on Premium Stones palette at the end</p>	 	POR





MAIN FUNCTIONAL OPTIONS

Please note that price for all the following options has to be added to the main model price

REF CODE			REUP
ICAMLCE-HZ20		HIGH IMPEDANCE ON BOARD 70/100V - 20W	€ 70

CUSTOMIZATION & ACCESSORIES

Please note that price for all the following options and accessories has to be added to the main model price

REF CODE			REUP
ICAMLCE-MTL-BLK		Only COVERS in MATT BLACK painted 304 Steel > see table on the next page	€ 180
ICAMLCE-MTL-SAT		Metal parts in SATIN-finished 304 Steel > see table on the next page	€ 480
ICAMLCE-MTL-POL316		Metal parts in POLISHED 316L Steel > see table on the next page	€ 770
ICAMLCE-MTL-BRS		Metal parts in oxidized BRASS > see table on the next page	€ 680
PLAST-ICAMLCE		Plaster treatment for travertines	€ 85
POL-ICAMLCE		Polishing treatment for all marbles	€ 70
COVER-ICAMLCE-B		PVC Basic Envelope	€ 130

METAL FINISHES TABLE



VERSION	GRID	COVER	JOINT	PLATE	POLE*
POLISHED STEEL 304	BLACK	POLISHED 304	POLISHED 304	BLACK	POLISHED 304
SATIN 304 STEEL	BLACK	SATIN 304	SATIN 304	BLACK	SATIN 304
POLISHED 316L STEEL	BLACK	POLISHED 316L	POLISHED 316L	BLACK	POLISHED 316L
BLACK PAINTED 304 STEEL	BLACK	MATT BLACK 304	POLISHED 304	BLACK	POLISHED 304
BRASS	BLACK	OXIDIZED BRASS	OXIDIZED BRASS	BLACK	OX. BRASS





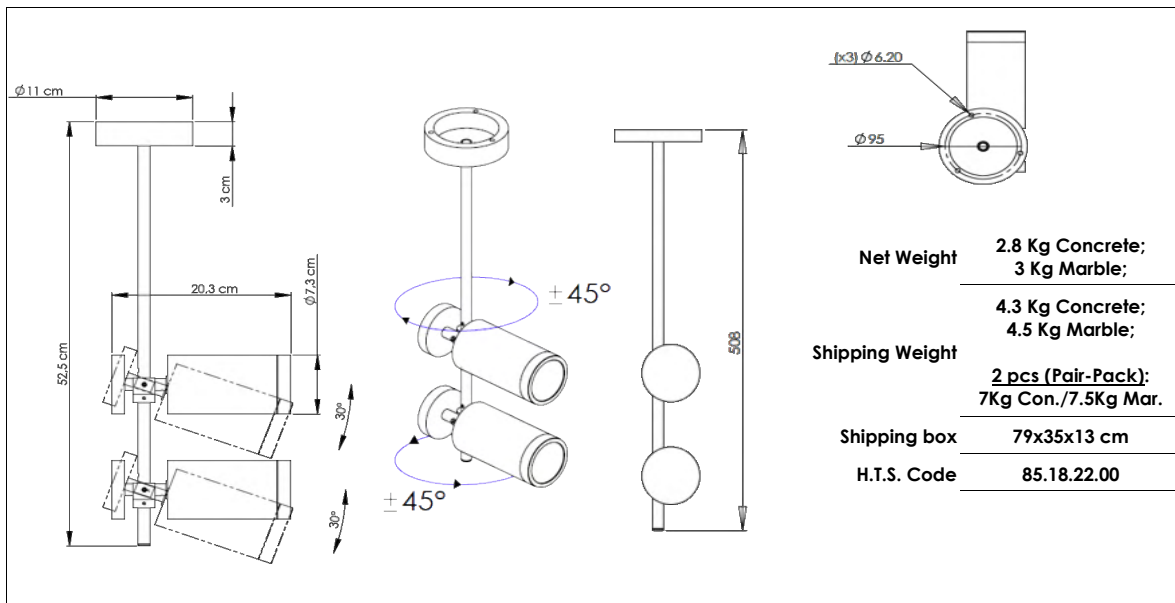

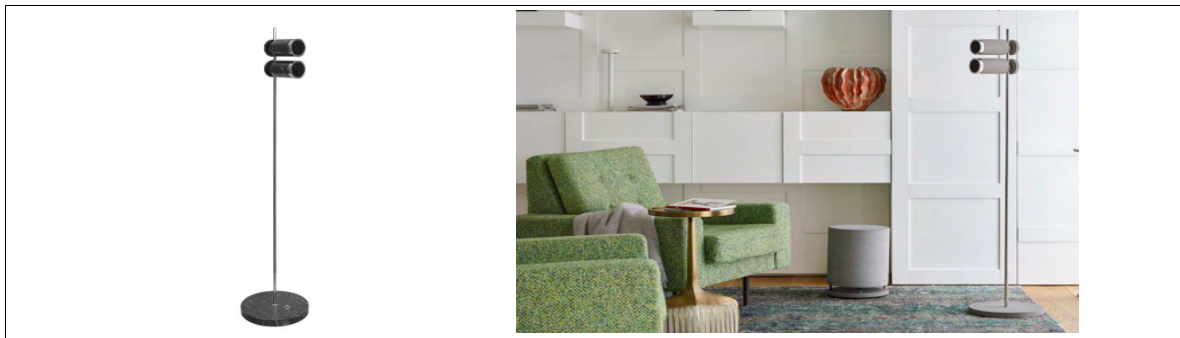

Standard version highlighted in red

*POLE+CAP+RING





ICARUS_MULTISTAND

REF CODE			REUP
ICAMLST-CN ICAMLST-CNP ICAMLST-CNW ICAMLST-CNR ICAMLST-CNB	 <p>ICARUS MULTISTAND_Concrete Without Crossover - Bodies in Concrete Metal parts in polished Steel 304 > <i>see table on the next page</i> See variations on Concrete palette at the end</p> <p> CN GREY CNP BLACK CNW WHITE CNR RED CNB OceanBlue </p>	 	€ 1.800
ICAMLST-ST01 ICAMLST-ST02 ICAMLST-ST03 ICAMLST-ST04	 <p>ICARUS MULTISTAND_Basic Stones Without Crossover - Bodies in Basic Stone Metal parts in polished Steel 304 > <i>see table on the next page</i> See variations on Basic Stones palette at the end</p> <p> ST01 TRVC ST02 TRVV ST03 CARW ST04 MARQ </p>	 	€ 3.700
ICAMLST-PM	 <p>ICARUS MULTISTAND_Premium Without Crossover - Bodies in Premium Stone Metal parts in polished Steel 304 > <i>see table on the next page</i> See variations on Premium Stones palette at the end</p>	 	POR





MAIN FUNCTIONAL OPTIONS

Please note that price for all the following options has to be added to the main model price

REF CODE		REUP
ICAMLST-HZ20	 <p>HIGH IMPEDANCE ON BOARD 70/100V - 20W</p>	€ 70

CUSTOMIZATION & ACCESSORIES

Please note that price for all the following options and accessories has to be added to the main model price

REF CODE		REUP
ICAMLST-MTL-BLK	 <p>Only COVERS in MATT BLACK painted 304 Steel > <i>see table on the next page</i></p>	€ 200
ICAMLST-MTL-SAT	 <p>Metal parts in SATIN-finished 304 Steel > <i>see table on the next page</i></p>	€ 500
ICAMLST-MTL-POL316	 <p>Metal parts in POLISHED 316L Steel > <i>see table on the next page</i></p>	€ 930
ICAMLST-MTL-BRS	 <p>Metal parts in oxidized BRASS > <i>see table on the next page</i></p>	€ 700
PLAST-ICAMLST	Plaster treatment for travertines	€ 170
POL-ICAMLST	Polishing treatment for all marbles	€ 140
COVER-ICAMLST-B	PVC Basic Envelope	€ 175

METAL FINISHES TABLE



VERSION	GRID	COVER	JOINT	WIRE	POLE*
POLISHED 304 STEEL	BLACK	POLISHED 304	304 POLISHED	BLACK	POLISHED 304
SATIN 304 STEEL	BLACK	SATIN 304	SATIN 304	BLACK	SATIN 304
POLISHED 316L STEEL	BLACK	POLISHED 316L	POLISHED 316L	BLACK	POLISHED 316L
BLACK PAINTED 304 STEEL	BLACK	MATT BLACK 304	POLISHED 304	BLACK	POLISHED 304
BRASS	BLACK	OXIDIZED BRASS	OXIDIZED BRASS	BLACK	OX. BRASS

Standard version highlighted in red

*POLE+CAP+RING

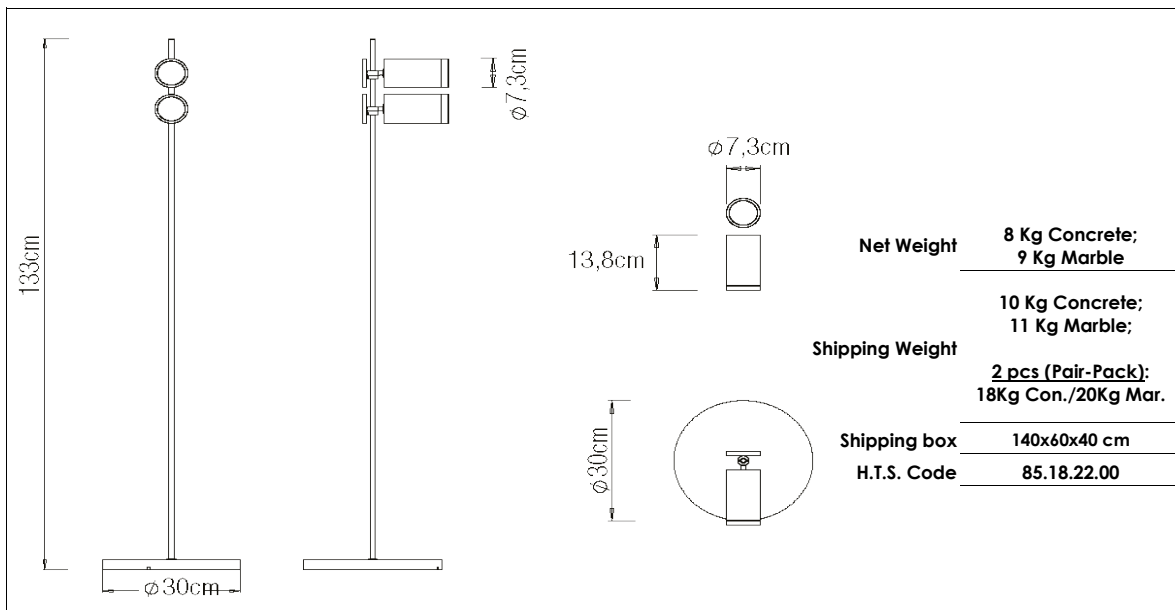

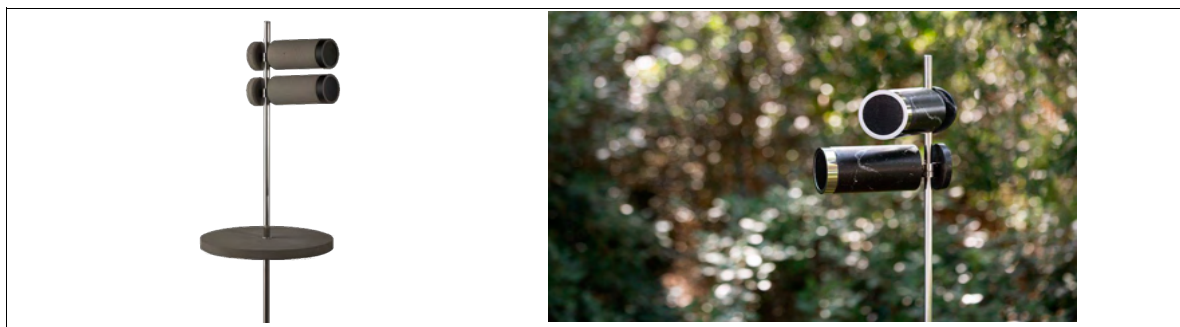

ICARUS_MULTIGROUND

REF CODE			REUP
ICAMLGR-CN ICAMLGR-CNP ICAMLGR-CNW ICAMLGR-CNR ICAMLGR-CNB		ICARUS MULTIGROUND_Concrete Without Crossover - Bodies in Concrete Metal parts in polished Steel 304 > see table on the next page See variations on Concrete palette at the end	 € 1.500
ICAMLGR-ST01 ICAMLGR-ST02 ICAMLGR-ST03 ICAMLGR-ST04		ICARUS MULTIGROUND_Basic Stones Without Crossover - Bodies in Basic Stone Metal parts in polished Steel 304 > see table on the next page See variations on Basic Stones palette at the end	 € 2.700
ICAMLGR-PM		ICARUS MULTIGROUND_Premium Without Crossover - Bodies in Premium Stone Metal parts in polished Steel 304 > see table on the next page See variations on Premium Stones palette at the end	 POR

MAIN FUNCTIONAL OPTIONS

Please note that price for all the following options has to be added to the main model price

REF CODE			REUP
ICAMLGR-HZ20		HIGH IMPEDANCE ON BOARD 70/100V - 20W	€ 70

CUSTOMIZATION & ACCESSORIES

Please note that price for all the following options and accessories has to be added to the main model price

REF CODE			REUP
ICAMLGR-MTL-BLK		Only COVERS in MATT BLACK painted 304 Steel > see table on the next page	€ 200
ICAMLGR-MTL-SAT		Metal parts in SATIN-finished 304 Steel > see table on the next page	€ 490
ICAMLGR-MTL-POL316		Metal parts in POLISHED 316L Steel > see table on the next page	€ 920
ICAMLGR-MTL-BRS		Metal parts in oxidized BRASS > see table on the next page	€ 700
PLAST-ICAMLGR		Plaster treatment for travertines	€ 85
POL-ICAMLGR		Polishing treatment for all marbles	€ 70
COVER-ICAMLGR-B		PVC Basic Envelope	€ 175

METAL FINISHES TABLE



VERSION	GRID	COVER	JOINT	WIRE	POLE*
POLISHED	BLACK	POLISHED 304	POLISHED 304	BLACK	POLISHED 304
STEEL 304 SATIN	BLACK	SATIN 304	SATIN 304	BLACK	SATIN 304
STEEL 316L POLISHED	BLACK	POLISHED 316L	POLISHED 316L	BLACK	POLISHED 316L
STEEL 304 BLACK PAINT	BLACK	MATT BLACK 304	POLISHED 304	BLACK	POLISHED 304
BRASS	BLACK	OXIDIZED BRASS	OXIDIZED BRASS	BLACK	OX. BRASS

Standard version highlighted in red

*POLE+CAP+RING

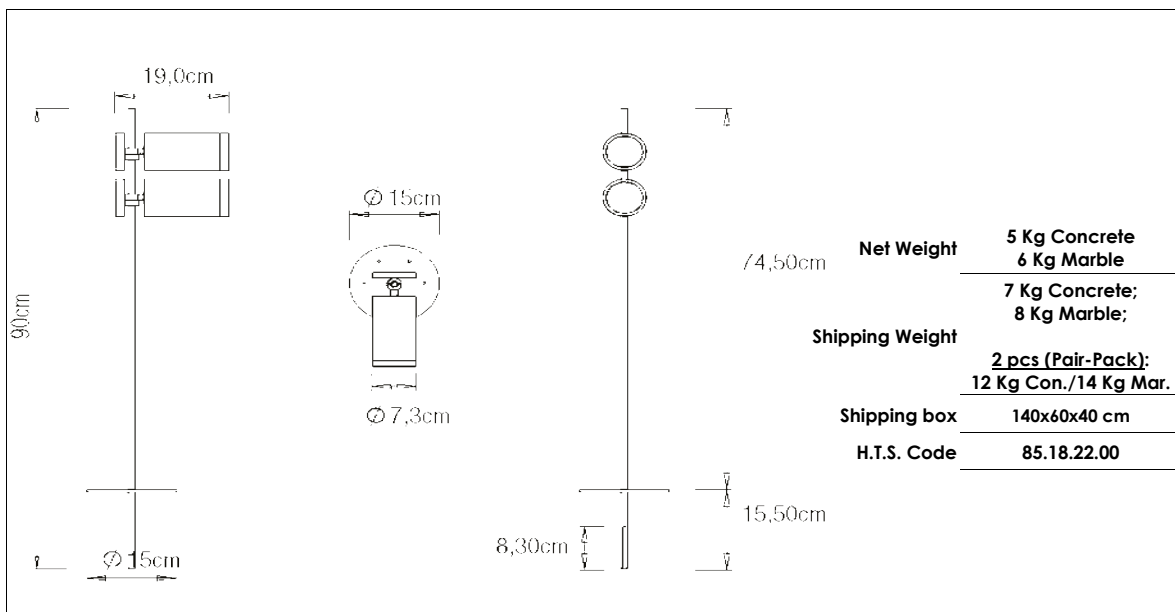

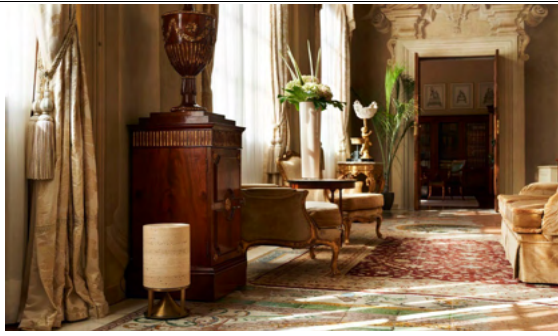

MEDIUM CYLINDER_450

REF CODE			REUP
MDCY-CN MDCY-CNP MDCY-CNW MDCY-CNR MDCY-CNB	 Medium Cylinder_Concrete Aluminium black painted base See variations on Concrete palette at the end CN CNP CNW CNR CNB GREY BLACK WHITE RED OceanBlue	 	€ 1.400
MDCY-ST01 MDCY-ST02 MDCY-ST03 MDCY-ST04	 Medium Cylinder_Basic Stones Aluminium black painted base See variations on Basic Stones palette at the end ST01 ST02 ST03 ST04 TRVC TRVW CARW MARG	 	€ 2.750
MDCY-PM	 Medium Cylinder_Premium Aluminium black painted base See variations on Premium Stones palette at the end	 	POR

REF CODE			REUPx2*
MDCY-PPCN MDCY-PPCNP MDCY-PPCNW MDCY-PPCNR MDCY-PPCNB	 PAIR-PACK SOLUTION 2 Medium Cylinders_Concrete Aluminium black painted base See variations on Concrete palette at the end CN CNP CNW CNR CNB GREY BLACK WHITE RED OceanBlue	 	€ 2.650

*prices refer to nr. 2 units in a single carton box

MAIN FUNCTIONAL OPTIONS





Please note that price for all the following options has to be added to the main model price

REF CODE			REUP
MDCY-XBSUB	 SUB VERSION WITH CROSSOVER		€ 150
MDCY-HZ30	 HIGH IMPEDANCE ON BOARD 70/100V - 30W		€ 100
MDCY-HZ60	 HIGH IMPEDANCE ON BOARD 70/100V - 60W		€ 130
MDCY-LM	 LIGHTING MOOD Led Strip in a notch around the loudspeaker area Supplied with (external) multivoltage power supply 3000 K - NO RGB		€ 220

CUSTOMIZATION & ACCESSORIES

Please note that price for all following options and accessories has to be added to the main model price

BASE OPTIONS

REF CODE			REUP
CYBS-RAL		Aluminium base painted in ALL RAL colors	€ 150
CYBS-SAT		SATIN 316L Steel base	€ 1.050
CYBS-POL		POLISHED 316L Steel base	€ 1.050
CYBS-BRS		Oxidised BRASS base	€ 1.100

OTHER ACCESSORIES





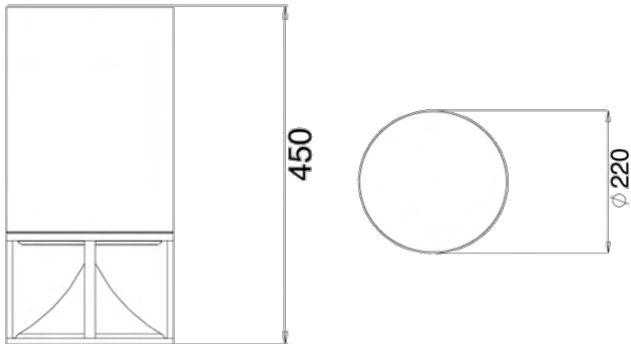

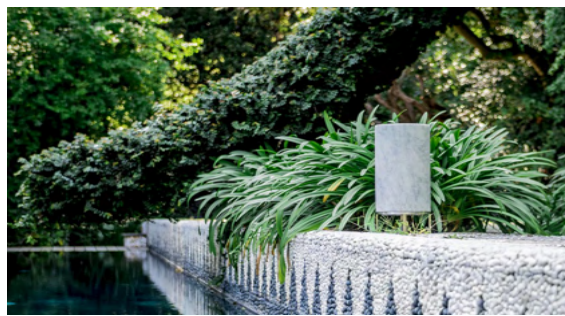

REF CODE			REUP
PLAST450		Plaster treatment for travertines	€ 225
POL450		Polishing treatment for marbles	€ 195
AF-CY-VER		Anti-theft for Grass land*	€ 120
SP-MDCY-VER		Sand proof system	€ 60
COVER-MDCY-B		PVC Basic Envelope	€ 70



* Hard floor Anti-theft system is also available (info on request)

	Net Weight	21 Kg Concrete; 23 Kg Marble; 19 Kg S. Surface; 48 Kg PAIR-PACK
	Shipping Weight	23 Kg Concrete; 25 Kg Marble; 20 Kg S. Surface; 50 Kg PAIR-PACK
	Shipping box	41x41x55.5 cm; 36x63x55.5 cm Pair-Pack
	H.T.S. Code	85.18.21.00



TALL CYLINDER_550



REF CODE			REUP
TLCY-CN TLCY-CNP TLCY-CNW TLCY-CNR TLCY-CNB	 <p>Tall Cylinder_Concrete Aluminium black painted base See variations on Concrete palette at the end</p> <p> CN GREY CNP BLACK CNW WHITE CNR RED CNB OceanBlue </p>	 	€ 1.550
TLCY-ST01 TLCY-ST02 TLCY-ST03 TLCY-ST04	 <p>Tall Cylinder_Basic Stones Aluminium black painted base See variations on Basic Stones palette at the end</p> <p> ST01 TRVC ST02 TRVW ST03 CARW ST04 MARQ </p>	 	€ 2.950
TLCY-PM	 <p>Tall Cylinder_Premium Aluminium black painted base See variations on Premium Stones palette at the end</p>	 	POR

			REUPx2*
TLCY-PPCN TLCY-PPCNP TLCY-PPCNW TLCY-PPCNR TLCY-PPCNB	 <p>PAIR-PACK SOLUTION 2 Tall Cylinders_Concrete Aluminium black painted base See variations on Concrete palette at the end</p> <p> CN GREY CNP BLACK CNW WHITE CNR RED CNB OceanBlue </p>	 	€ 2.950

*prices refer to nr. 2 units in a single carton box

MAIN FUNCTIONAL OPTIONS





Please note that price for all the following options has to be added to the main model price

REF CODE			REUP
TLCY-XBSUB		SUB VERSION WITH CROSSOVER	€ 150
TLCY-HZ30		HIGH IMPEDANCE ON BOARD 70/100V - 30W	€ 100
TLCY-HZ60		HIGH IMPEDANCE ON BOARD 70/100V - 60W	€ 130
TLCY-LM		LIGHTING MOOD Led Strip in a notch around the loudspeaker area Supplied with (external) multivoltage power supply 3000 K - NO RGB	€ 220

CUSTOMIZATION & ACCESSORIES

Please note that price for all following options and accessories has to be added to the main model price

BASE OPTIONS

REF CODE			REUP
CYBS-RAL		Aluminium base painted in ALL RAL colors	€ 150
CYBS-SAT		SATIN 316L Steel base	€ 1.050
CYBS-POL		POLISHED 316L Steel base	€ 1.050
CYBS-BRS		Oxidised BRASS base	€ 1.100

OTHER ACCESSORIES

REF CODE			REUP
PLAST450		Plaster treatment for travertines	€ 225
POL450		Polishing treatment for marbles	€ 195
AF-CY-VER		Anti-theft for Grass land*	€ 120
SP-TLCY-VER		Sand proof system	€ 60
COVER-TLCY-B		PVC Basic Envelope	€ 70

* Hard floor Anti-theft system is also available (info on request)

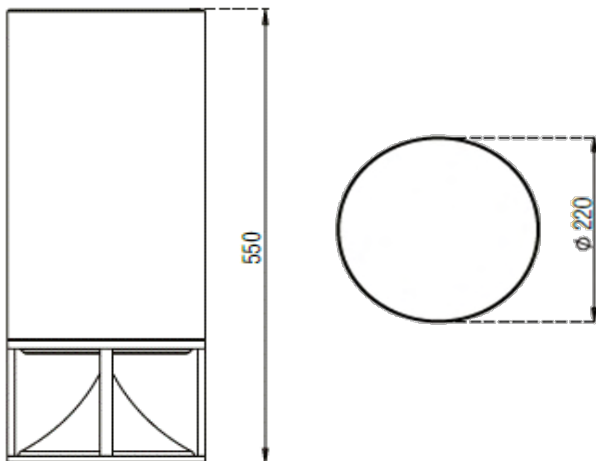
	Net Weight	23 Kg Concrete; 25 Kg Marble; 53 Kg PAIR-PACK
	Shipping Weight	25 Kg Concrete 27 Kg Marble; 21 Kg S. Surface; 55 Kg PAIR-PACK
	Shipping box	41x41x66.5 cm; 36x63x67 cm Pair-Pack
	H.T.S. Code	85.18.21.00

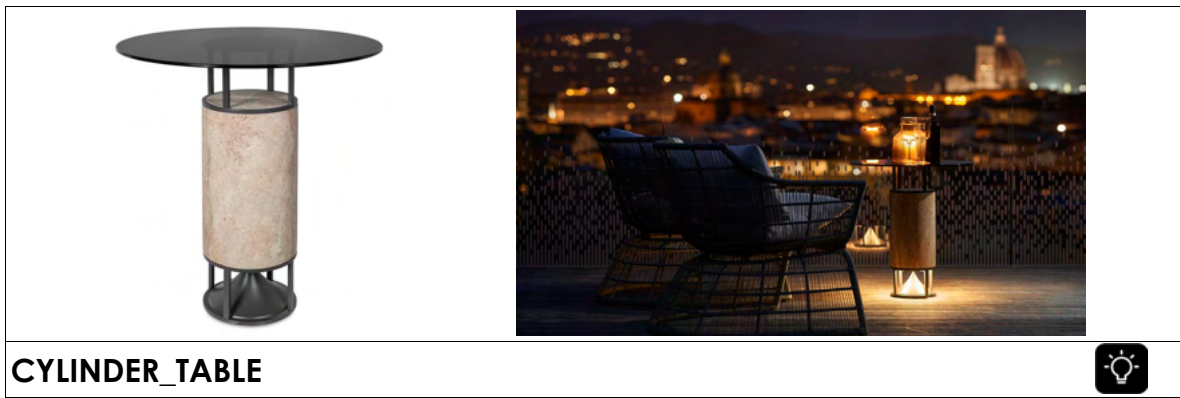

CYLINDER_TABLE



REF CODE			REUP
TABCYL-CN TABCYL-CNP TABCYL-CNW TABCYL-CNR TABCYL-CNB	 Cylinder Table_Concrete Aluminium black painted base Clear or smoked glass Table Lighting led strip included (3000 K -NO RGB) See variations on Concrete palette at the end	 	€ 3.400
TABCYL-ST01 TABCYL-ST02 TABCYL-ST03 TABCYL-ST04	 Cylinder Table_Basic Stones Aluminium black painted base Clear or smoked glass Table Lighting led strip included (3000 K - NO RGB) See variations on Basic Stones palette at the end	 	€ 5.500
TABCYL-PM	 Cylinder_Premium Stones Aluminium black painted base Clear or smoked glass Table Lighting led strip included (3000 K - NO RGB) See variations on Premium Stones palette at the end	 	POR

Find all Accessories, base and finishing options on page 19

MAIN FUNCTIONAL OPTIONS













Please note that price for all the following options has to be added to the main model price

REF CODE			REUP
TLCY-XBSUB		SUB VERSION WITH CROSSOVER	€ 155
TLCY-HZ30		HIGH IMPEDANCE ON BOARD 70/100V - 30W	€ 100
TLCY-HZ60		HIGH IMPEDANCE ON BOARD 70/100V - 60W	€ 130

	Net Weight Shipping Weight Shipping Box (1 box + glass plate packaging) H.T.S. CODE	31 Kg Concrete; 33 Kg Marble; 33 Kg Concrete; 35 Kg Marble; 38x88x39cm (box) 60x60x5cm 85.18.21.00
--	---	---





SPHERE_360

REF CODE				REUP
SF360-CN SF360-CNP SF360-CNW SF360-CNR SF360-CNB	 <p>Sphere 360_Concrete Brass black painted base See variations on Concrete palette at the end</p> <p>CN GREY CNP BLACK CNW WHITE CNR RED CNB OceanBlue</p>	 		€ 2.250
SF360-TC	 <p>Sphere 360_Terracotta Brass black painted base See variations on Terracotta palette at the end</p> <p>TC TERR</p>	 		€ 2.250
SF360-ST01 SF360-ST02 SF360-ST03 SF360-ST04	 <p>Sphere 360_Basic Stones Brass black painted base See variations on Basic Stones palette at the end</p> <p>ST01 TRVC ST02 TRVW ST03 CARW ST04 MARQ</p>	 		€ 4.650
SF360-PM	 <p>Sphere 360_Premium Brass black painted base See variations on Premium Stones palette at the end</p>	 		POR

MAIN FUNCTIONAL OPTIONS





Please note that price for all the following options has to be added to the main model price

REF CODE			REUP
SF360-XBSUB		SUB VERSION WITH CROSSOVER	€ 150
SF360-HZ30		HIGH IMPEDANCE ON BOARD 70/100V - 30W	€ 90
SF360-HZ60		HIGH IMPEDANCE ON BOARD 70/100V - 60W	€ 120
SF360-LM		LIGHTING MOOD Led Strip in a notch around the loudspeaker area Supplied with (external) multivoltage power supply 3000 K - NO RGB	€ 250

CUSTOMIZATION & ACCESSORIES

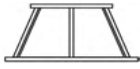
Please note that price for all following options and accessories has to be added to the main model price

BASE OPTIONS

REF CODE			REUP
SFBS-RAL		Three-leg brass base painted in ALL RAL colors	€ 330
SFBS-SAT		Three-leg Steel 316L base, SATIN finishing	€ 520
SFBS-POL		Three-leg Steel 316L base, POLISHED finishing	€ 520
SFBS-BRS		Three-leg oxidised BRASS base	€ 370
SF-SLOT		SLOT on MARBLE Deflector	€ 230

OTHER ACCESSORIES

REF CODE			REUP
PLAST360		Plaster Treatment for Travertines 360mm	€ 240
POL360		Polishing treatment for marbles	€ 190
VHGRS-SF-VER		Anti-theft for Grass land	€ 300
VHFLR-SF-VER		Anti-theft for Hard floor	€ 210
SP-360-VER		Sand proof System	€ 60
COVER-SF360-B		PVC Basic Envelope	€ 110
COVER-SF360-P		PVC Premium Cover	€ 250

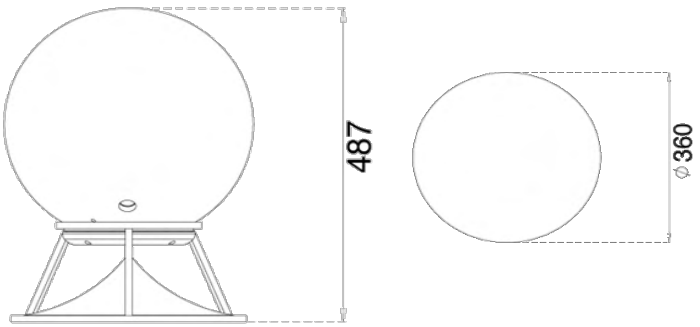
	Net Weight	24 Kg Concrete; 25 Kg Marble; 15 Kg Terracotta
	Shipping Weight	26 Kg Concrete; 27.5 Kg Marble; 18.5 Kg Terracotta
	Shipping box	49x48x75.5 cm
	H.T.S. Code	85.18.21.00

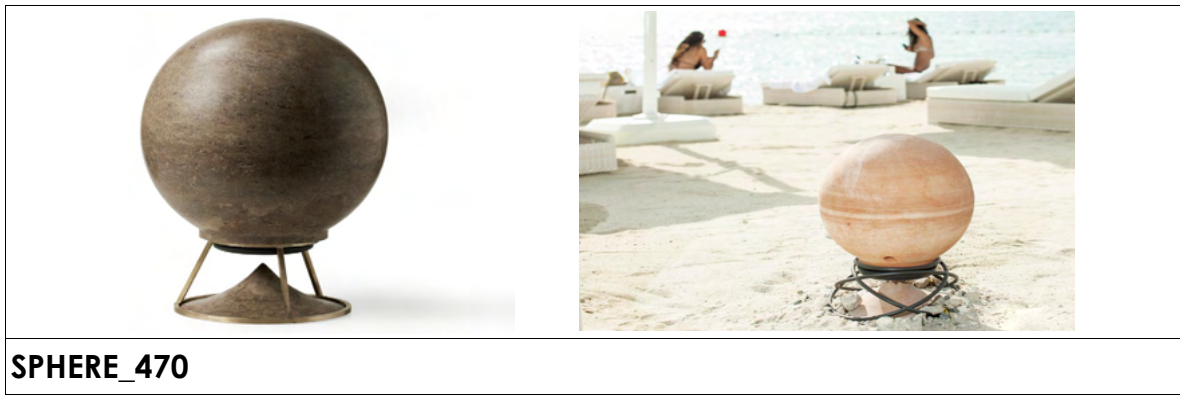

SPHERE_470

REF CODE			REUP	
SF470-ST01		<p>Sphere 470_Basic Stones Brass black painted base See variations on Basic Stones palette at the end</p> <p>ST01 TRVC ST02 TRVW ST03 CARW ST04 MARQ</p>	 	POR
SF470-ST02				
SF470-ST03				
SF470-ST04				
SF470-PM		<p>Sphere 470_Premium Brass black painted base See variations on Premium Stones palette at the end</p>	 	POR

MAIN FUNCTIONAL OPTIONS





Please note that price for all the following options has to be added to the main model price

REF CODE			REUP
SF470-XBSUB		SUB VERSION WITH CROSSOVER	€ 150
SF470-HZ30		HIGH IMPEDANCE ON BOARD 70/100V - 30W	€ 90
SF470-HZ60		HIGH IMPEDANCE ON BOARD 70/100V - 60W	€ 120
SF470-LM		LIGHTING MOOD Led Strip in a notch around the loudspeaker area Supplied with (external) multivoltage power supply 3000 K - NO RGB	€ 250

CUSTOMIZATION & ACCESSORIES

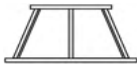
Please note that price for all following options and accessories has to be added to the main model price

BASE OPTIONS

REF CODE		REUP
SFBS-RAL	 Three-leg brass base painted in ALL RAL colors	€ 330
SFBS-SAT	 Three-leg Steel 316L base, SATIN finishing	€ 520
SFBS-POL	 Three-leg Steel 316L base, POLISHED finishing	€ 520
SFBS-BRS	 Three-leg oxidised BRASS base	€ 370
SF-SLOT	SLOT on MARBLE Deflector	€ 230





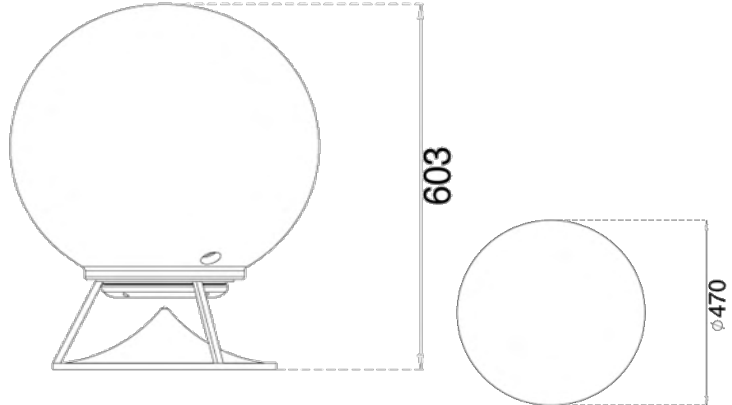

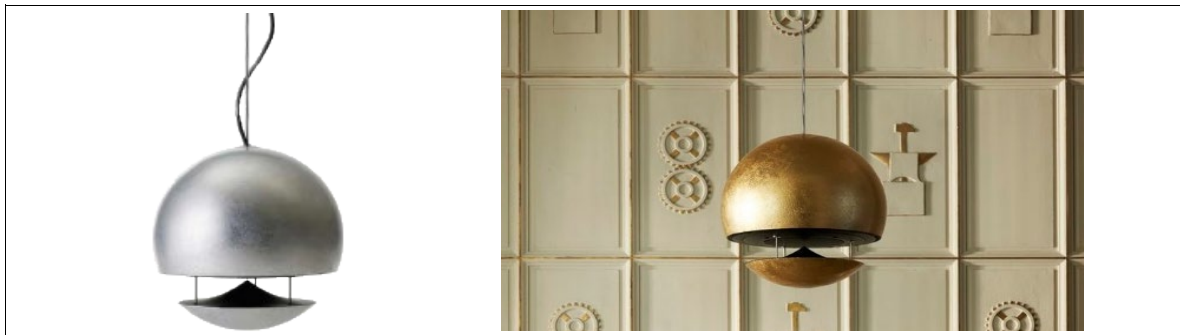





OTHER ACCESSORIES

REF CODE		REUP
PLAST470	Plaster Treatment for Travertines 470mm	€ 240
POL470	Polishing treatment for marbles	€ 190
VHGRS-SF-VER	Anti-theft for Grass land	€ 300
VHFLR-SF-VER	Anti-theft for Hard floor	€ 210
SP-470-VER	Sand proof System	€ 60
COVER-SF470-B	PVC Basic Envelope	€ 110
COVER-SF470-P	PVC Premium Cover	€ 250

	Net Weight	52 Kg
	Shipping Weight	55 Kg
	Shipping box	61x62x87 cm
	H.T.S. Code	85.18.21.00



SPHERINA_AIR

REF CODE			REUP
SF3000-AIRC� SF3000-AIRCNP SF3000-AIRC�W SF3000-AIRC�R SF3000-AIRC�B		Spherina Air_Concrete Stainless Steel bars See variations on Concrete palette at the end CN GREY CNP BLACK CNW WHITE CNR RED CNB OceanBlue	  € 1.800
SF3000-AIRST01 SF3000-AIRST02 SF3000-AIRST03 SF3000-AIRST04		Spherina Air_Basic Stones Stainless Steel bars See variations on Basic Stones palette at the end ST01 TRVC ST02 TRVW ST03 CARW ST04 MARQ	  € 3.850
SF300-AIRPM		Spherina Air_Premium Stainless Steel bars See variations on Premium Stones palette at the end	  POR
SF300-AIRGLD SF300-AIRSLV SF300-AIRCPR		Spherina Air_Shine Line Black Concrete body covered with either Gold, Silver or Copper leaves (only body and lower part of deflector) Stainless Steel bars Only for indoor use See variations on Shine-Line palette at the end GLD Gold SLV Silver CPR Copper	   € 3.200

REF CODE			REUPx2*
SF300-PPAIRC� SF300-PPAIRCNP SF300-PPAIRC�W SF300-PPAIRC�R SF300-PPAIRC�B	 	PAIR-PACK SOLUTION 2 Spherinas Air_Concrete Stainless Steel bars See variations on Concrete palette at the end CN GREY CNP BLACK CNW WHITE CNR RED CNB OceanBlue	  € 3.500

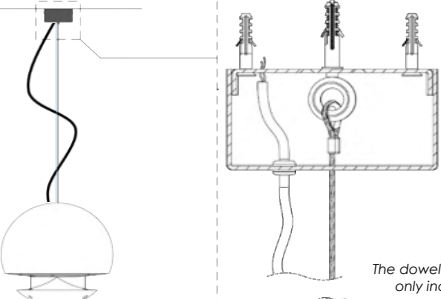

*prices refer to nr. 2 units in a single carton box

ALL ABOVE MENTIONED MODELS ARE PRICED CONSIDERING THE FOLLOWING FEATURES

<p>The hanging steel cable is the perfect solution to mount the speaker by using a really sleek system, which combines the supporting steel and the audio and light cable.</p>	<p>The Hanging Steel Cable system</p>  <p>The dowel screws are only indicative</p>	<p>The hanging steel cable is supplied with the Ceiling Rose (matt black is the standard version), which allows you to hang the loudspeaker like a standard suspended lamp (see drawing here).</p>
--	---	--

MAIN FUNCTIONAL OPTIONS

Please note that price for all the following options has to be added to the main model price

REF CODE		REUP
SF300-AIR-XBSUB	 SUB VERSION WITH CROSSOVER	€ 160
SF300-LM	 LIGHTING MOOD Led Strip in a notch around the loudspeaker area Supplied with (external) multivoltage power supply 3000 K - NO RGB	€ 250

CUSTOMIZATION & ACCESSORIES

Please note that price for all options and accessories has to be added to the main model price

ACCESSORIES

REF CODE		REUP
RSW	 Ceiling Rose - Matt White version	€ 20
SP-SF300-VER	Sand proof system	€ 135
COVER-SF300-P	PVC Premium Cover	€ 180

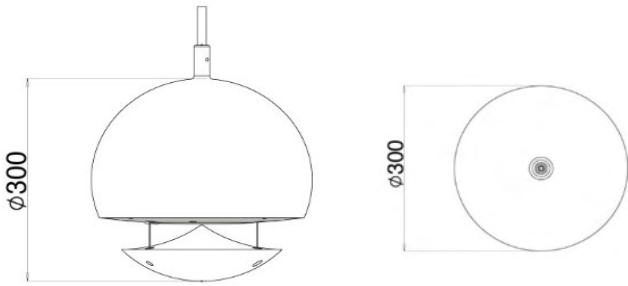
	Net Weight	15 Kg Concrete; 16.5 Kg Marble
	Shipping Weight	17 Kg Concrete; 18.5 Kg Marble
	Shipping box	40x40x40 cm; 42x79x39 cm Pair-Pack
	H.T.S. Code	85.18.21.00

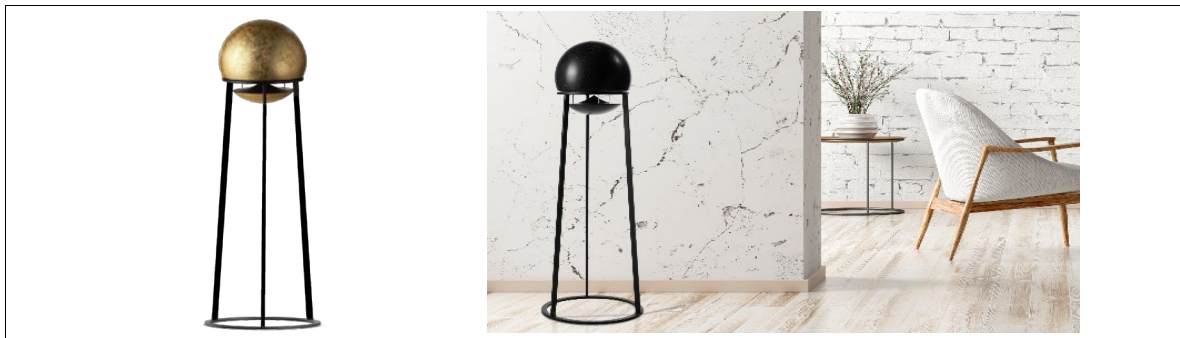





SPHERINA_MIDAIR







only indoors

REF CODE			REUP	
SF3000-MIDCN SF3000-MIDCNP SF3000-MIDCNW SF3000-MIDCNR SF3000-MIDCNB		<p>Spherina MidAir_Concrete Body in Concrete Matt Black painted metal Stand</p> <p>Only for indoor use See variations on Concrete palette at the end</p> <p> CN GREY CNP BLACK CNW WHITE CNR RED CNB OceanBlue </p>	  	€ 2.600

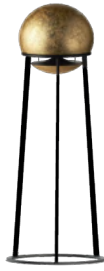

SF3000-MIDST01 SF3000-MIDST02 SF3000-MIDST03 SF3000-MIDST04		<p>Spherina MidAir_Basic Stones Body and base in Basic Stones Matt Black painted metal Stand</p> <p>Only for indoor use See variations on Premium Stones palette at the end</p> <p> ST01 TRVC ST02 TRVW ST03 CARW ST04 MARQ </p>	  	€ 4.900
--	--	---	---	---------

SF300-MID-PM		<p>Spherina MidAir_Premium Body and base in Premium Stones Matt Black painted metal Stand</p> <p>Only for indoor use See variations on Premium Stones palette at the end</p>	  	POR
--------------	---	---	---	-----

SF300-MIDGLD SF300-MIDSLV SF300-MIDCPR		<p>Spherina MidAir_Shine Line Black Concrete body covered with either Gold, Silver or Copper leafs (only body and lower part of deflector) Matt Black painted metal Stand</p> <p>Only for indoor use See variations on Shine-Line palette at the end</p> <p> GLD Gold SLV Silver CPR Copper </p>	  	€ 4.100
--	---	--	---	---------

MAIN FUNCTIONAL OPTIONS

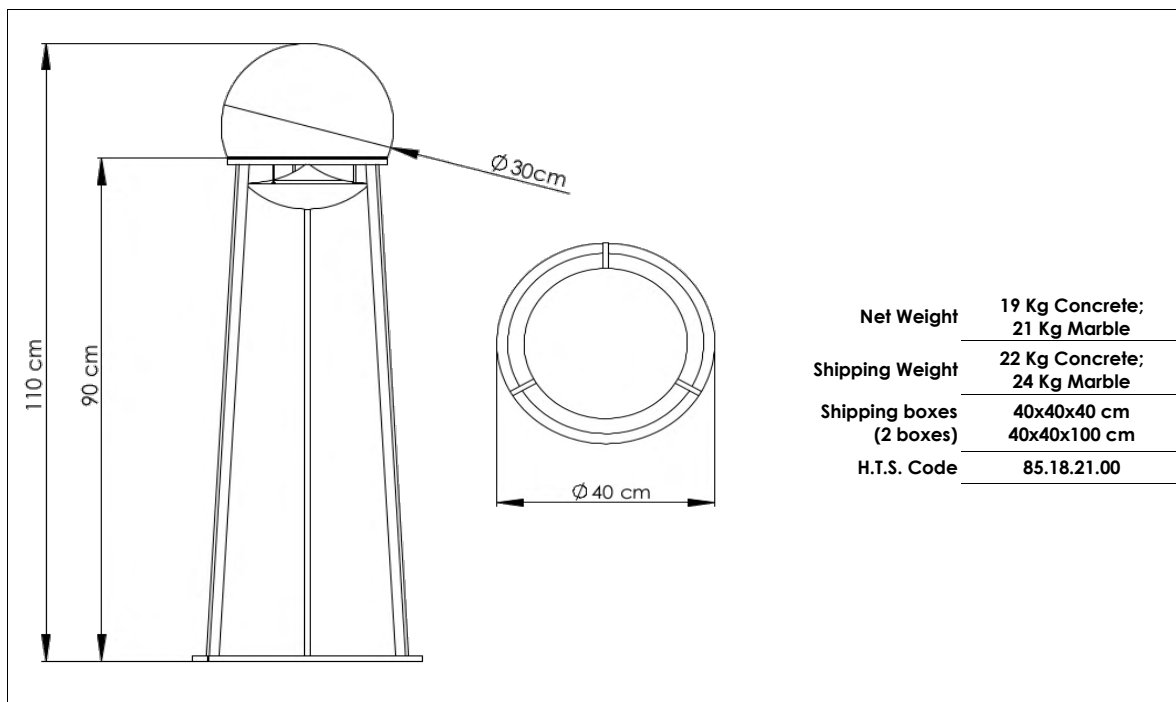

Please note that price for all the following options has to be added to the main model price

REF CODE			REUP
SF300-MID-XBSUB		SUB VERSION WITH CROSSOVER	€ 155
SF300-MID-LM		LIGHTING MOOD Led Strip in a notch around the loudspeaker area Supplied with (external) multivoltage power supply 3000 K - NO RGB	€ 240

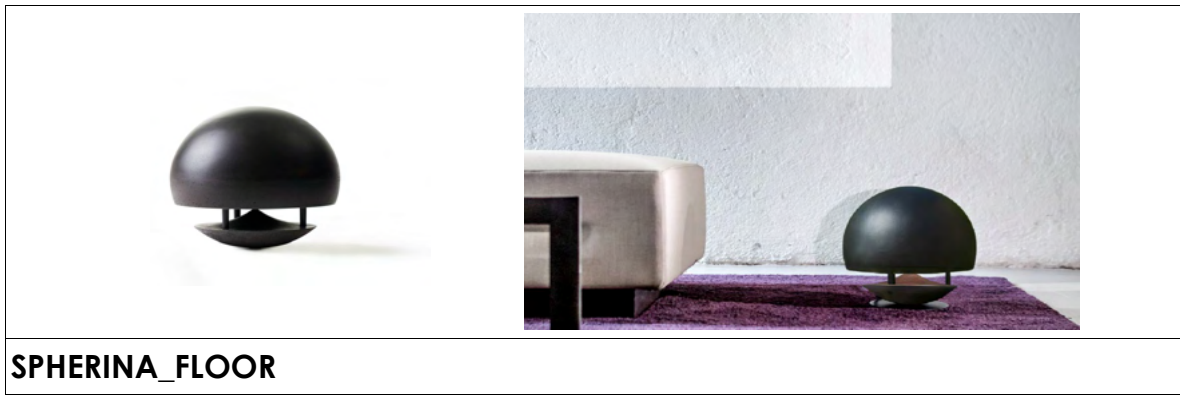









SPHERINA_FLOOR

REF CODE			REUP
SF3000-FLRCN SF3000-FLRCNP SF3000-FLRCNW SF3000-FLRCNR SF3000-FLRCNB	 <p>Spherina Floor_Concrete Aluminium black painted legs See variations on Concrete palette at the end</p> <p> CN GREY CNP BLACK CNW WHITE CNR RED CNB OceanBlue </p>	 	€ 1.600

SF3000-FLRST01 SF3000-FLRST02 SF3000-FLRST03 SF3000-FLRST04	 <p>Spherina Floor_Basic Stones Aluminium black painted legs See variations on Basic Stones palette at the end</p> <p> ST01 TRVC ST02 TRVW ST03 CARW ST04 MARQ </p>	 	€ 3.700
--	---	---	---------

SF300-FLR-PM	 <p>Spherina Floor_Premium Aluminium black painted legs See variations on Premium Stones palette at the end</p>	 	POR
--------------	---	--	-----

SF300-FLRGLD SF300-FLRSLV SF300-FLRCPR	 <p>Spherina Floor_Shine Line Black Concrete body covered with either Gold, Silver or Copper leaves (only body and lower part of deflector) Aluminium black painted legs</p> <p>Only for indoor use See variations on Shine-Line palette at the end</p> <p> GLD Gold SLV Silver CPR Copper </p>	  	€ 2.950
--	--	---	---------

REF CODE			REUPx2*
SF300-PPFLRCN SF300-PPFLRCNP SF300-PPFLRCNW SF300-PPFLRCNR SF300-PPFLRCNB	 <p>PAIR-PACK SOLUTION 2 Spherinas Floor_Concrete Aluminium black painted legs See variations on Concrete palette at the end</p> <p> CN GREY CNP BLACK CNW WHITE CNR RED CNB OceanBlue </p>	 	€ 3.100

*prices refer to nr. 2 units in a single carton box

MAIN FUNCTIONAL OPTIONS

Please note that price for all the following options has to be added to the main model price

REF CODE			REUP
SF300-FLR-XBSUB		SUB VERSION WITH CROSSOVER	€ 160

CUSTOMIZATION & ACCESSORIES

Please note that price for all options and accessories has to be added to the main model price





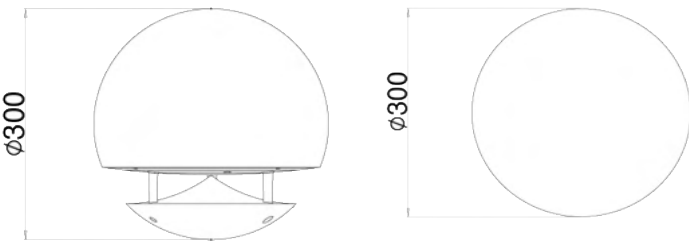







ACCESSORIES

REF CODE			REUP
AF-SF300-VER		Anti-theft for Grass land	€ 105
SP-SF300-VER		Sand proof system	€ 135
COVER-SF300-B		PVC Basic Envelope	€ 65
COVER-SF300-P		PVC Premium Cover	€ 170
PLX-DISC		Plaxiglass Disc	€ 20

	Net Weight	15 Kg Concrete; 16.5 Kg Marble
	Shipping Weight	17 Kg Concrete; 18.5 Kg Marble
	Shipping box	40x40x40 cm; 42x79x39 cm Pair-Pack
	H.T.S. Code	85.18.21.00





CUBINO_300

REF CODE			REUP
CB300-CN  CB300-CNP  CB300-CNW  CB300-CNR  CB300-CNB 	 <p>Cubino_Concrete Aluminium black painted legs See variations on Concrete palette at the end</p>	 	€ 1.850
	CN  GREY CNP  BLACK CNW  WHITE CNR  RED CNB  OceanBlue		

MAIN FUNCTIONAL OPTIONS

Please note that price for all the following options has to be added to the main model price

REF CODE			REUP
CB300-XBSUB		SUB VERSION WITH CROSSOVER	€ 155
CB300-HZ30		HIGH IMPEDANCE ON BOARD 70/100V - 30W	€ 90
CB300-HZ60		HIGH IMPEDANCE ON BOARD 70/100V - 60W	€ 120

CUSTOMIZATION & ACCESSORIES

ACCESSORIES





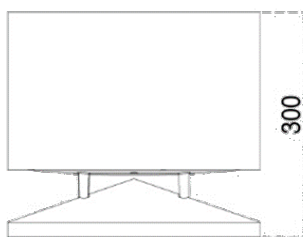
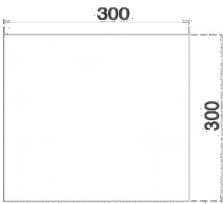

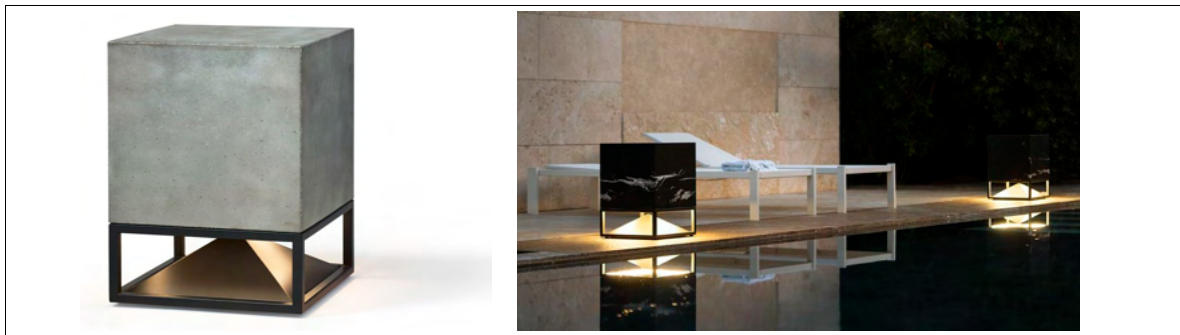

Please note that price for all options and accessories has to be added to the main model price

REF CODE			REUP
AF-CB300-VER		Anti-theft for Grass land	€ 100
SP-CB300-VER		Sand proof system	€ 135
COVER-CB300-B		PVC Basic Envelope	€ 80

		<table border="1"> <tr> <td>Net Weight</td> <td>30 Kg</td> </tr> <tr> <td>Shipping Weight</td> <td>31 Kg</td> </tr> <tr> <td>Shipping Box</td> <td>39.5x39.5x40 cm</td> </tr> <tr> <td>H.T.S. CODE</td> <td>85.18.21.00</td> </tr> </table>	Net Weight	30 Kg	Shipping Weight	31 Kg	Shipping Box	39.5x39.5x40 cm	H.T.S. CODE	85.18.21.00
Net Weight	30 Kg									
Shipping Weight	31 Kg									
Shipping Box	39.5x39.5x40 cm									
H.T.S. CODE	85.18.21.00									





CUBE_400

REF CODE			REUP
CB400-CN CB400-CNP CB400-CNW CB400-CNR CB400-CNB	 <p>Cube 400_Concrete Steel 304 black painted base Deflector in concrete See variations on concrete palette at the end</p> <p> CN GREY CNP BLACK CNW WHITE CNR RED CNB OceanBlue </p>	 	€ 3.450
CB400-ST01 CB400-ST02 CB400-ST03 CB400-ST04	 <p>Cube 400_Basic Stones Steel 304 black painted base (including deflector) See variations on Basic Stones palette at the end</p> <p> ST01 TRVC ST02 TRVW ST03 CARW ST04 MARQ </p>	 	€ 5.800
CB400-PM	 <p>Cube 400_Premium Steel 304 black painted base (including deflector) See variations on premium stones palette at the end</p>	 	POR





MAIN FUNCTIONAL OPTIONS

Please note that price for all the following options has to be added to the main model price



REF CODE			REUP
CB400-XBSUB		SUB VERSION WITH CROSSOVER	€ 180
CB400-HZ30		HIGH IMPEDANCE ON BOARD 70/100V - 30W	€ 100
CB400-HZ60		HIGH IMPEDANCE ON BOARD 70/100V - 60W	€ 130
CB400-LM		LIGHTING MOOD Led Strip in a notch around the loudspeaker area Supplied with (external) multivoltage power supply 3000 K - NO RGB	€ 420

CUSTOMIZATION & ACCESSORIES

BASE OPTIONS FOR ALL CUBES (DEFLECTOR IN METAL)

REF CODE			REUP
CBBS-RAL		Steel 304 Base painted in ALL RAL colors and metal deflector	€ 400
CBBS-SAT		SATIN Steel 316L base and metal deflector	€ 1.200
CB-POL316		POLISHED Steel 316L base and metal deflector	€ 1.300
CBBS-BRS		Oxidized BRASS base and metal deflector	€ 1.600

BASE OPTIONS ONLY FOR CUBES IN CONCRETE (DEFLECTOR IN CONCRETE)

REF CODE			REUP
CBBS-INXCN		SATIN Steel 316L base and concrete deflector	€ 950
CBBS-BRSCN		Oxidized BRASS base and concrete deflector	€ 950

ACCESSORIES

REF CODE			REUP
PLAST400		Plaster treatment for travertines	€ 400
POL400		Polishing treatment for all marbles	€ 330
SP-CB400-VER		Sand proof System	€ 130
COVER-CB400-P		PVC Premium Cover	€ 230

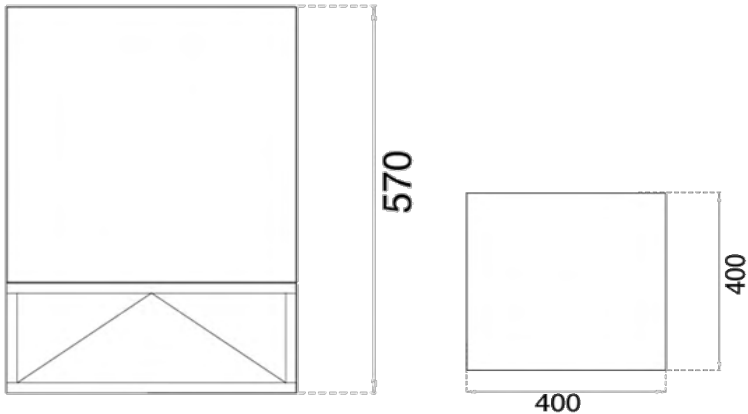
	Net Weight	136 Kg Concrete; 142 Kg Marble
	Shipping Weight	138 Kg Concrete; 144 Kg Marble
	Shipping box	51x51x68 cm
	H.T.S. Code	85.18.21.00





CUBE_400-TEN

REF CODE			REUP
CB400T-CN CB400T-CNP CB400T-CNW CB400T-CNR CB400T-CNB	 <p>Cube 400-TEN_Concrete Steel 304 black painted base Deflector in concrete See variations on concrete palette at the end</p> <p> CN GREY CNP BLACK CNW WHITE CNR RED CNB OceanBlue </p>	 	€ 3.700
CB400T-ST01 CB400T-ST02 CB400T-ST03 CB400T-ST04	 <p>Cube 400-TEN_Basic Stones Steel 304 black painted base (including deflector) See variations on Basic Stones palette at the end</p> <p> ST01 TRVC ST02 TRVV ST03 CARW ST04 MARQ </p>	 	€ 6.200
CB400T-PM	 <p>Cube 400-TEN_Premium Steel 304 black painted base (including deflector) See variations on premium stones palette at the end</p>	 	POR

Find all Customization options and Accessories on page 33



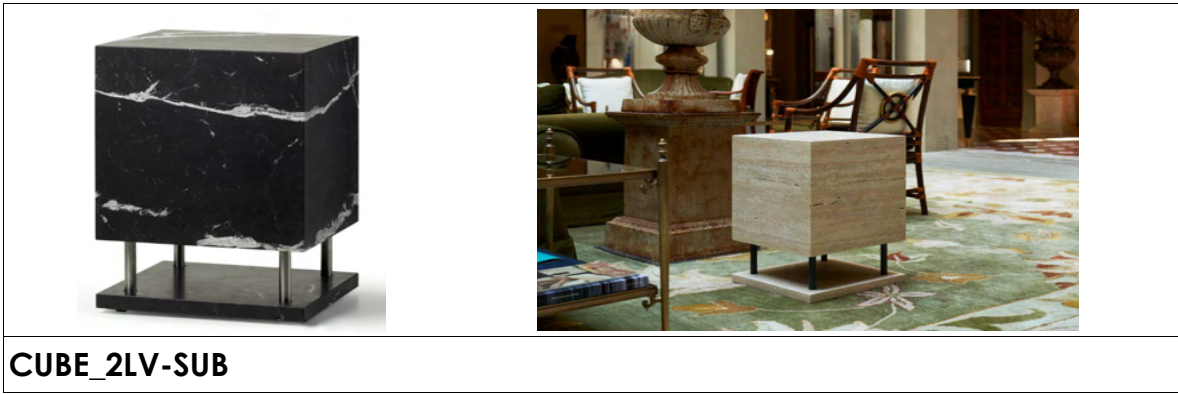

MAIN FUNCTIONAL OPTIONS

Please note that price for all the following options has to be added to the main model price

REF CODE			REUP
CB400T-XBSUB		SUB VERSION WITH CROSSOVER	€ 180
CB400T-HZ30		HIGH IMPEDANCE ON BOARD 70/100V - 30W	€ 100
CB400T-HZ60		HIGH IMPEDANCE ON BOARD 70/100V - 60W	€ 130
CB400T-LM		LIGHTING MOOD Led Strip in a notch around the loudspeaker area Supplied with (external) multivoltage power supply 3000 K - NO RGB	€ 420





CUBE_2LV-SUB

REF CODE			REUP
CB2LV-CN CB2LV-CNP CB2LV-CNW CB2LV-CNR CB2LV-CNB	 <p>Cube 2LV Sub_Concrete Aluminium black painted legs See variations on Concrete palette at the end</p> <p> CN GREY CNP BLACK CNW WHITE CNR RED CNB OceanBlue </p>		€ 3.100
CB2LV-ST01 CB2LV-ST02 CB2LV-ST03 CB2LV-ST04	 <p>Cube 2LV Sub_Basic Stones Aluminium black painted legs See variations on Basic Stones palette at the end</p> <p> ST01 TRVC ST02 TRVW ST03 CARW ST04 MARQ </p>		€ 7.400
CB2LV-PM	 <p>Cube 2LV Sub_Premium Stones Aluminium black painted legs See variations on Premium Stones palette at the end</p>		POR

MAIN FUNCTIONAL OPTIONS



Please note that price for all the following options has to be added to the main model price

REF CODE		REUP
CB2LV-HZ30	 HIGH IMPEDANCE ON BOARD 70/100V - 30W	€ 90
CB2LV-HZ60	 HIGH IMPEDANCE ON BOARD 70/100V - 60W	€ 120

CUSTOMIZATION & ACCESSORIES

Please note that price for all following options and accessories has to be added to the main model price

LEGS OPTIONS

REF CODE			REUP
2LV-LGS-INX		Steel 316L Legs (Safin or Gunmetal finishing)	€ 170
2LV-LGS-BRS		Oxidized Brass Legs	€ 230

ACCESSORIES



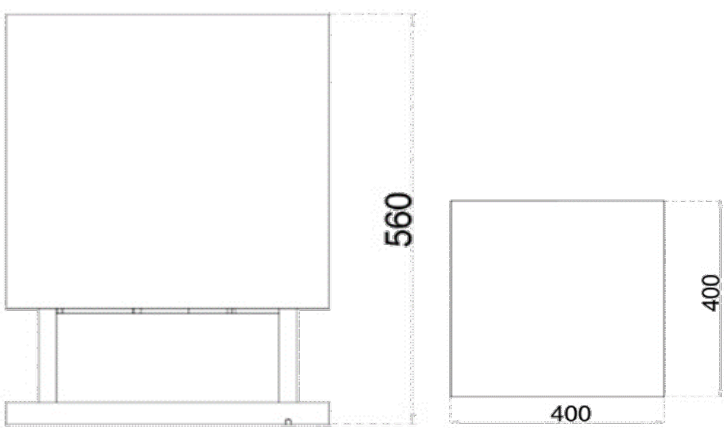

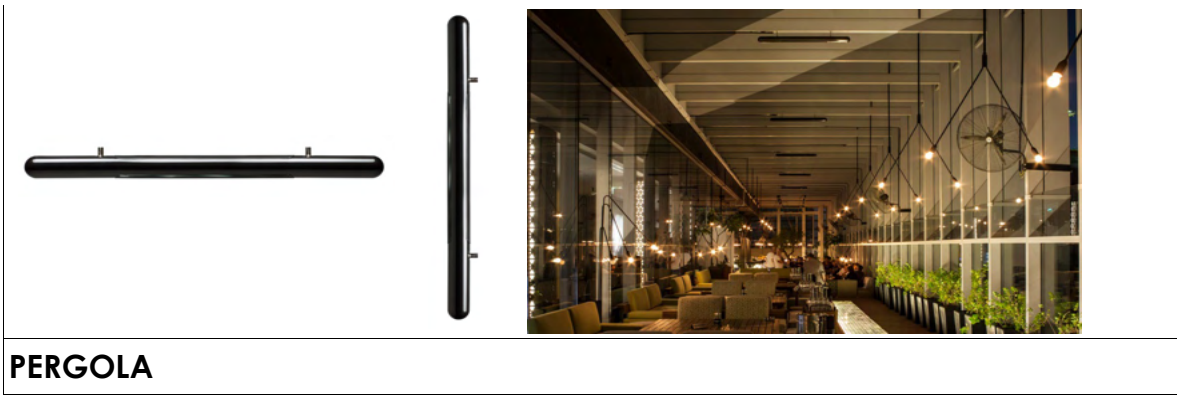

REF CODE			REUP
PLAST400-2LV		Plaster treatment for travertines	€ 600
POL400-2LV		Polishing treatment for marbles	€ 500



Net Weight	78 Kg Concrete; 87 Kg Marble
Shipping Weight	81 Kg Concrete; 90 Kg Marble
Shipping box	51x51x68 cm
H.T.S. Code	85.18.21.00





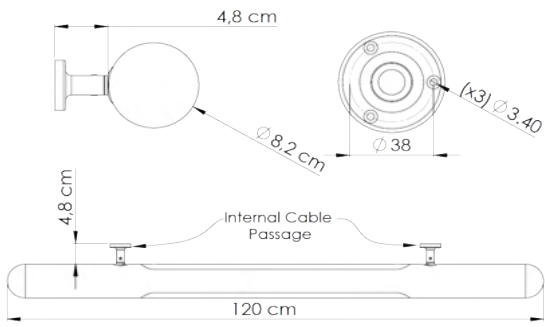
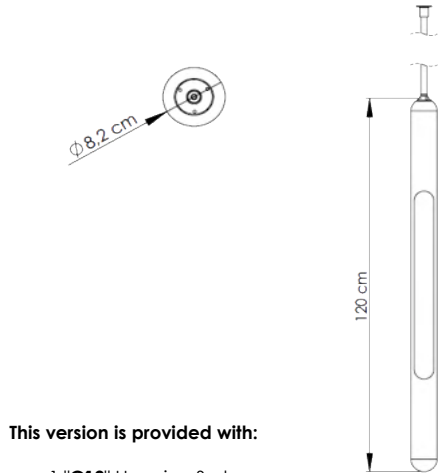

PERGOLA

REF CODE			REUP
PERGO-LA	 Pergola_Line Array Carbon Fiber	 	€ 5.450
PERGO-PS	 Pergola_Point Source Carbon Fiber	 	€ 5.450

HORIZONTAL VERSION	VERTICAL VERSION
 <p>This version is provided with:</p> <ul style="list-style-type: none"> - CROSSOVER On Board - no. 2 "X5HOR" Hanging Systems 	 <p>This version is provided with:</p> <ul style="list-style-type: none"> - no.1 "C12" Hanging System - no.1 Steel Tube (min. 10cm - max 100cm)

CUSTOMIZATION & ACCESSORIES

Please note that price for all following options and accessories has to be added to the main model price

REF CODE			REUP
PERGO-PS-XE	 EXTERNAL CROSSOVER FOR HIGH SPL (in IP box) (only for Point Source version)		€ 70
PERGO-BODY-PNT	Painting other RAL (only body, with black grid)		€ 520
HSTD	 Standard ceiling Anchoring (2 pcs)		€ 0
C12	 Simple ceiling Steel Hanging		€ 100
HSM	 Ceiling vertical Iron		€ 165
HPM	 Ceiling vertical Steel		€ 375
SP-PERGO-VER	Sand proof Filter		€ 190
COVER-PERGO-P	PVC Premium Cover		€ 300



Find all details for Hanging Tube Systems on page 44

Net Weight 5 Kg
Shipping Weight 6 Kg



Shipping Box 27.5x16x15 cm
H.T.S. Code 85.18.22.00



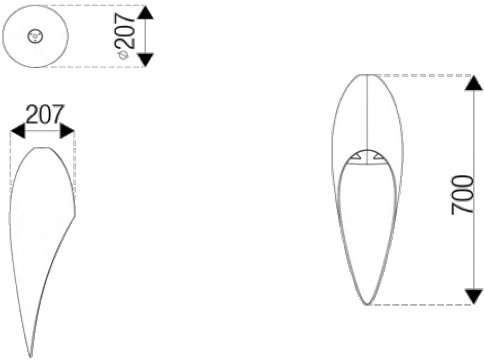

AERIAL

REF CODE				REUP
SMDRP		Small Drop Composite material (black or white) Supplied with external crossover (boxed)		€ 4.900

	Net Weight 6 Kg Gross Weight 8 Kg Shipping Box 86x32x35 cm H.T.S. Code 85.18.21.00
--	---

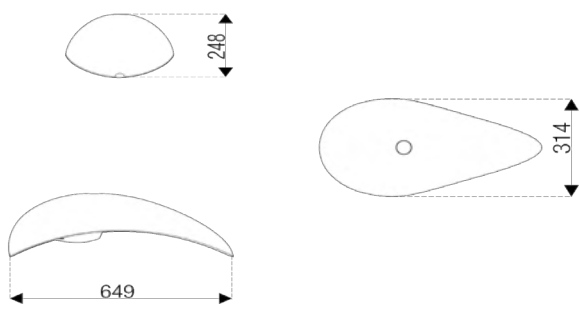
REF CODE				REUP
SMHLM		Small Helmet Composite material (black or white) Supplied with external crossover (boxed)		€ 4.400

	Net Weight 6 Kg Gross Weight 8 Kg Shipping Box 78x41x41 cm H.T.S. Code 85.18.21.00
---	---

REF CODE			REUP
SHRK	 <p>Shark_Sub Composite material (black or white) No crossover on board (passive)</p>		€ 5.300

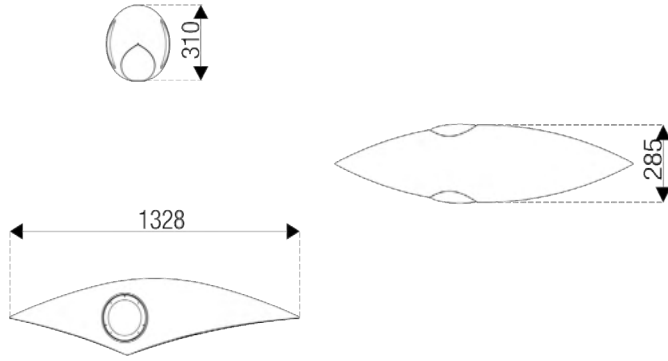



Net Weight 13 Kg

Gross Weight 15 Kg

Shipping Box 145x35x45 cm

H.T.S. Code 85.18.21.00

REF CODE			REUP
DROP	 <p>Drop Composite material (black or white)</p>		€ 6.200

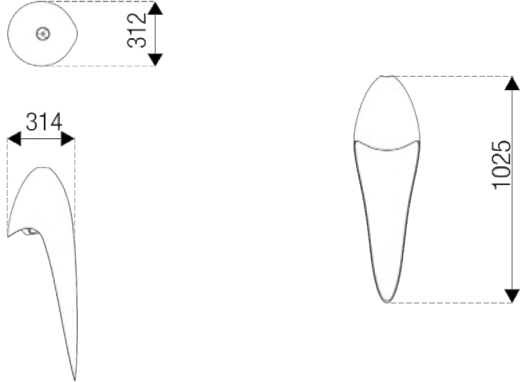

Net Weight 8 Kg

Gross Weight 10 Kg







Shipping Box 127x35x40 cm

H.T.S. Code 85.18.21.00

CUSTOMIZATION & ACCESSORIES

Please note that price for all following options and accessories has to be added to the main model price

HANGING TUBE SYSTEMS

REF CODE			REUP
HSTD		Simple Hangings (Aluminium) F12; FK12; K12	€ 60
C12		Simple Ceiling Stainless Steel Hanging	€ 100
HSM		Iron Hanging not orientable	€ 165
HPM		Steel Hanging not orientable	€ 375
H45D		Orientable 45° Steel Hanging	€ 375
H90D		Orientable 90° Steel Hanging	€ 500
HWSP		Widening Plate for orientable hanging	€ 60

Find all details for Hanging Tube Systems on page 44

ACCESSORIES

REF CODE			REUP
SUSP-RAL		Painting others RAL	POR
SP-SUSP-VER		Sand proof System*	€ 210
COVER-PS		PVC Premium Cover small (for Small Drop/S. Helmet)	€ 330
COVER-PL		PVC Premium Cover large (for Shark/Drop)	€ 430

*Not available for Shark



AS AMPLIFIERS_ Master Volume
Ice Power Technology



AMPLIFIERS

AS AMPLIFIERS_ Master Volume

Ice Power Technology - fitted with table top mounting accessories, rack mounting kit included

REF CODE		REUP
ASM2EVO	AS-M2EVO 2 ch x 1000W @4Ω Proprietary Audio processor	€ 1.300

POWERSOFT AMPLIFIERS

REF CODE		REUP
PS2404DSP+D	QUATTROCANALI 2404 DSP+D 4x600W Amplifier Platform (@4Ω and @8Ω) with DSP (Armonia Plus) and Dante™	€ 3.250
PS2404DSP	QUATTROCANALI 2404 DSP 4x600W Amplifier Platform (@4Ω and @8Ω) with DSP (Armonia Plus)	€ 3.100
PS2404	QUATTROCANALI 2404 4x600W Amplifier Platform (@4Ω and @8Ω)	€ 2.550
PS1204DSP+D	QUATTROCANALI 1204 DSP+D 4x300W Amplifier Platform (@4Ω and @8Ω) with DSP (Armonia Plus) and Dante™	€ 2.650
PS1204DSP	QUATTROCANALI 1204 DSP 4x300W Amplifier Platform (@4Ω and @8Ω) with DSP (Armonia Plus)	€ 2.490
PS1204	QUATTROCANALI 1204 4x300W Amplifier Platform (@4Ω and @8Ω)	€ 1.930
PSMEZ322	MEZZO 322 A 2x1 60W Amplifier Platform (@4Ω and @8Ω) with DSP (Armonia Basic)	€ 990
PSMEA602	MEZZO 602 A 2x300W (@4Ω and @8Ω) with DSP (Armonia Basic)	€ 1.250
PSMEZ324	MEZZO 324 A 4x80W (@4Ω and @8Ω) with DSP (Armonia Basic)	€ 1.190
PSMEZ604	MEZZO 604 A 4x1 50W (@4Ω and @8Ω) with DSP (Armonia Basic)	€ 1.500



A.S. PROMO KITS

SAMPLE KITS

REF CODE			REUP
ASKIT-BASIC		<p>AS Basic Sample Kit</p> <p>This Basic Sample Kit folder is the most practical tool to show the variety and quality of finishings of the A.S. materials</p>	€ 150
ASKIT-PM		<p>AS Premium Sample Kit</p> <p>This elegant A.S. wooden Premium Sample Kit box is the the best tool to hold a range of our exclusive stones, concretes, wood and metals in your hand and get a feel of the various qualities and surface finishes.</p>	€ 390

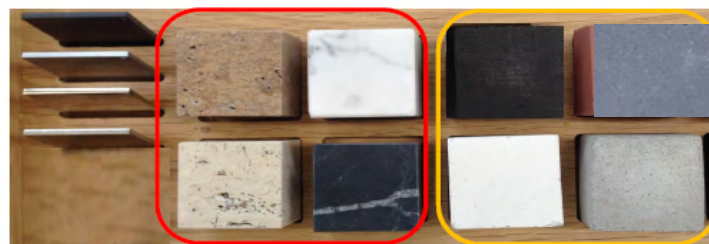
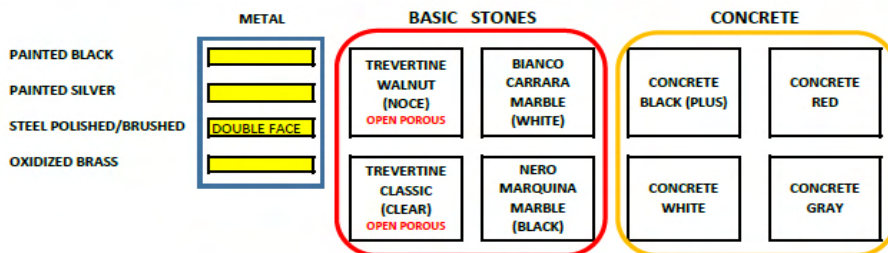

PREMIUM SAMPLE KIT

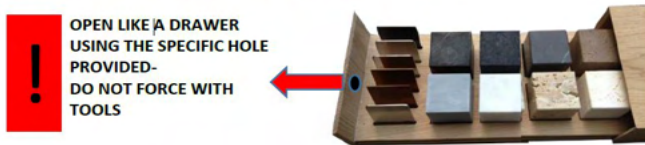

HOW TO OPEN THE BOX!





CATALOGUES & LEAFLETS

REF CODE			REUP
AS-CAT22		<p>no.10 "THE SOUND COLLECTION #1" AS_Catalogue</p> <p>2022 edition Architettura Sonora's Full Catalogue including Product Datasheets (A4 - 144 pages)</p>	€ 100
AS-LEAF22		<p>no.30 "THE SOUND OVERVIEW #1" AS_Leaflet</p> <p>2022 edition Architettura Sonora's Leaflet (A4 - 14 pages)</p>	€ 35

T-SHIRTS & BAGS

REF CODE			REUP
AS-TSHIRT		<p>no.5 AS T-Shirt</p> <p>Short Sleeve T-Shirt 100% Black Cotton (Sizes M - L - XL)</p>	€ 75
AS-BAG		<p>no.10 AS BAG_KNAPSACK</p> <p>Organic Cotton backpack (135 grams) with AS logo screen printing</p>	€ 75

AS PROMO KITS

REF CODE			REUP
AS-PROKIT-A		<p>AS PROMO KIT - A</p> <ul style="list-style-type: none"> - n. 1 AS Basic Sample Kit - n. 20 "The Sound Collection" Full Catalogue - n. 60 "The Sound Overview" AS Leaflet - n. 10 AS Bag (Organic Cotton Backpack) - n. 10 AS 100% Cotton T-Shirt 	€ 580
AS-PROKIT-B		<p>AS PROMO KIT - B</p> <ul style="list-style-type: none"> - n. 2 AS Basic Sample Kit - n. 30 "The Sound Collection" Full Catalogue - n. 120 "The Sound Overview" AS Leaflet - n. 20 AS Bag (Organic Cotton Backpack) - n. 20 AS 100% Cotton T-Shirt 	€ 990

HANGING TUBE SYSTEMS FOR SUSPENDED MODELS

Simple Aluminium Hanging Tubes

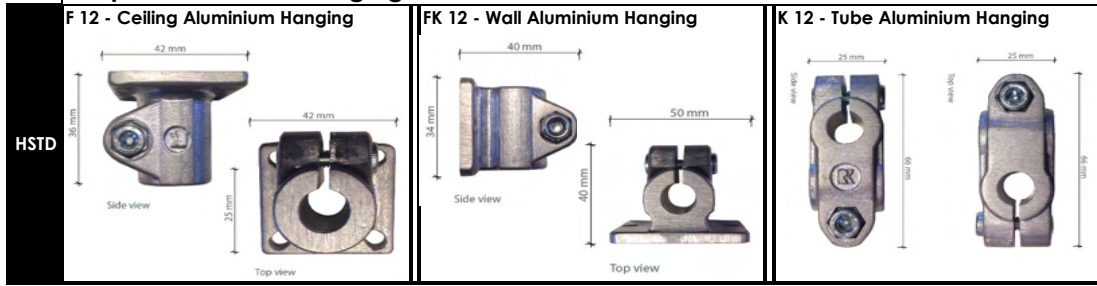

Other Solutions

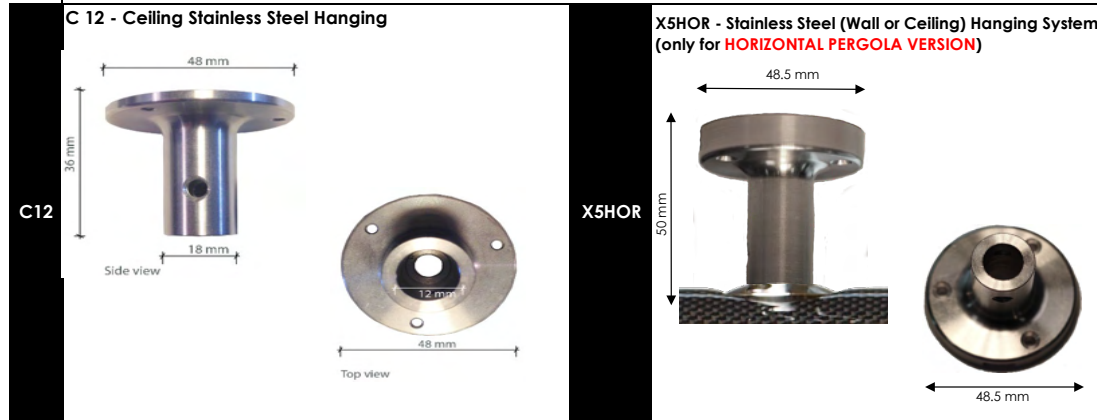

Premium Hanging Tube Typologies

Iron (HSM) and Steel (HPM) hanging NOT orientable

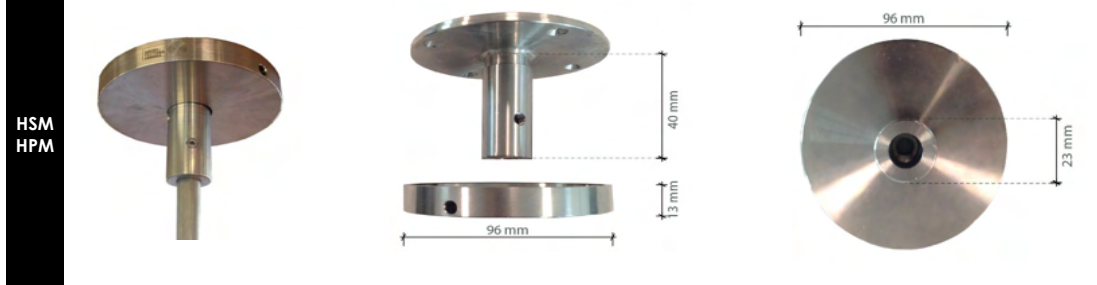

H45D - Orientable 45° Stainless Steel hanging

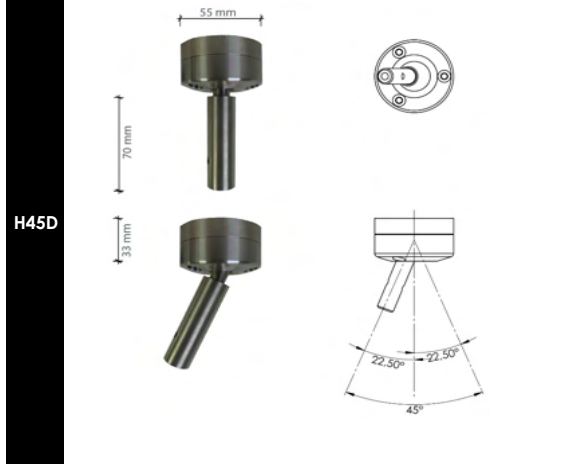

H90D - Orientable 90° Stainless Steel hanging

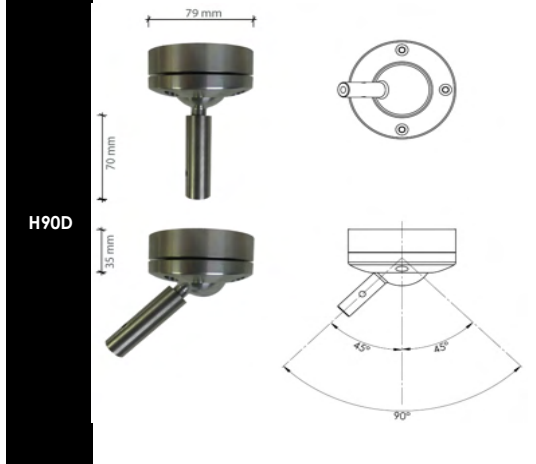



A.S. • PALETTES

EXCLUSIVE UNIQUENESS

Please note that these palettes must be considered as reference; the delivered item may look slightly different being many the things affecting the ultimate graining and coloration of natural stone and terracottas, such as underground springs, mineral deposits, earth shifts, temperature, natural solutions in the earth and pressure.

Enjoy **A.S. EXCLUSIVE UNIQUENESS**, we really feel proud about. It is not just about the product, each A.S. sound module is a very special and inimitable piece of **Sound Art**.

BASIC Stones



PREMIUM Stones

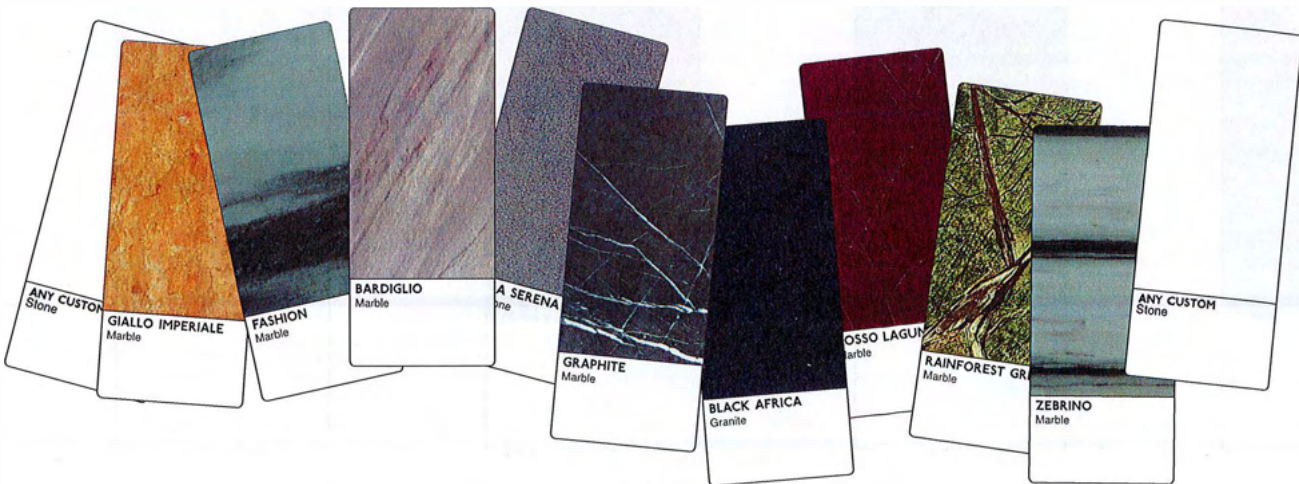

All stones not included in the "**Basic**" family are considered "**Premium**". Please verify with A.S. staff the availability and prices of ANY stone. The above mentioned variations are just a reference, but we will do our best in order to meet any needs of personalization and customization for your special projects.

CONCRETE Collection

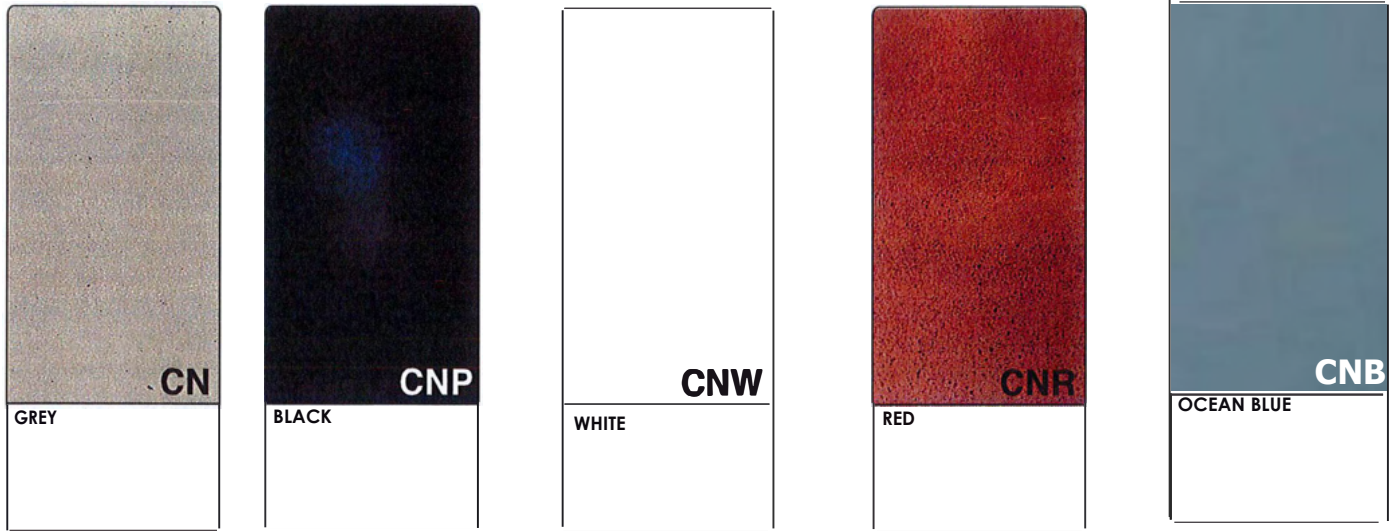

SHINE Special Edition



NB: The SHINE Special Edition is available for the SPHERINA Collection only

TERRACOTTA

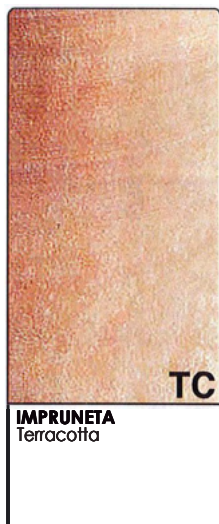

ALUMINUM

